

RJ45, male, straight, 4 poles, RJ45, male, straight, 4 poles, shielded, Industrial Ethernet 100 MBit/s

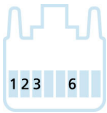
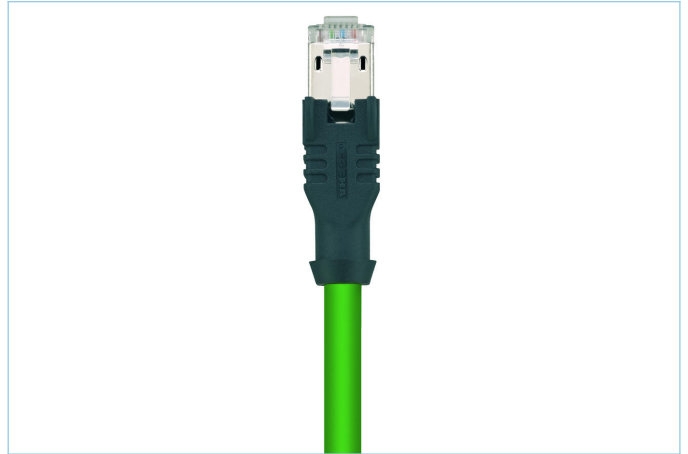
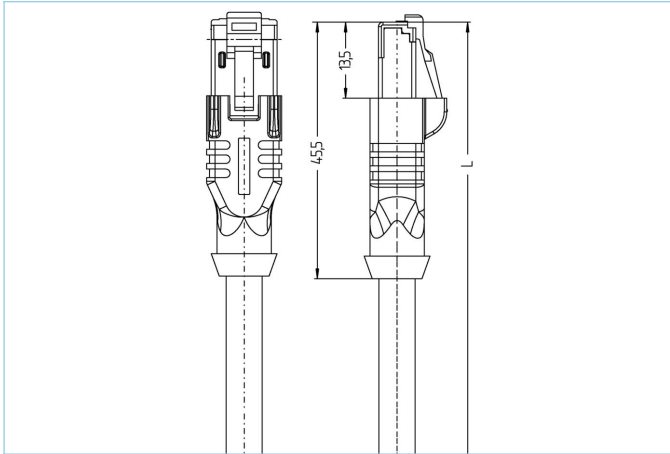

Product data

Item description	IE-RJ45SS4.003-4-IE-RJ45SS4.003/S5200
Item-No.	8806036
Length	4m
Customs tariff-No.	85444290
Step-File	IE-RJ45SS4-m-IE-RJ45SS4.stp
EAN	4047106316631

Technical data	A-side	B-side
Connector	male, straight, RJ45	male, straight, RJ45
Number of pins	4	4
Pin assignment	1 YE, 2 OG, 3 WH, 6 BU	1 YE, 2 OG, 3 WH, 6 BU
Allocation	Industrial	Industrial
Rated voltage	60V	60V
Current load (at 40°C)	1A	1A
Insulation resistance	≥10 ⁹ Ω	≥10 ⁹ Ω
Transmission features	Cat5e	Cat5e
Ambient temperature product	-40°C...+70°C	-40°C...+70°C
Contact material	Metal, CuZn, gold-plated	Metal, CuZn, gold-plated
Contact-carrier material	Plastic	Plastic
Grip body material	Plastic, TPU, BK	Plastic, TPU, BK
Shielding	with shielding	with shielding
Material of shielding housing	Metal, CuZn, nickel-plated	Metal, CuZn, nickel-plated
Standards	IEC 60603-7-5	IEC 60603-7-5
Degree of protection (mounted)	IP20	IP20
Mechanical life-cycle	>750 mating cycles	>750 mating cycles
Degree of pollution	1	1

Advanced technical data UL

Cable web	Cat5e, PVC, UL, S5200, PROFINET
------------------	--

Shielded, PVC-cable for industrial applications. The cable is AWM-Style 21694 verified or meets the Cat5e (electrical properties of EN 50288-2-1) requirements.

Outer diameter of jacket	6.50 mm
Cable-jacket material	PVC
Jacket color	GN, similar RAL6018
Wire cross-section	1 x 4 x AWG22, star quad
Wire insulation material	PVC
Wire colors	WH, BU, OG, YE
Wire structure	7 x 0.25 mm
Bending radius (fixed)	3 x Ø-cable
Bending radius (repeated)	7 x Ø-cable
Temperature range (repeated)	-40°C...+80°C
Temperature range (fixed)	-20°C...+60°C
Shielding	with shielding
Halogen-free	No
UL AWM style	UL AWM 21694
Transmission features	Cat5e
Rated voltage cable	600 V UL rating
Special features	flame retardant, high flexibility, microbes resistant, oil resistant, oil- and fuel resistant, ozone resistant, PROFINET Type B, recyclable, RoHs compliant, acid- and alkali resistant, seawater resistant, UV resistant

Classification	
-----------------------	--

eCl@ss 6.0	27061801
eCl@ss 7.0	27060308
eCl@ss 8.0	27060308
eCl@ss 9.0	27060308
ETIM 5.0	EC002599
ETIM 6.0	EC002599

Accessories

Unlocking clip for RJ45

<https://www.escha.net/en/products/standard/accessories-for-connectivity?p=1&o=3&n=15&f=807>