

M12, female, angled, 4 poles, grip body with thread, rail approved

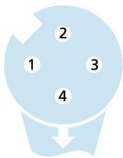
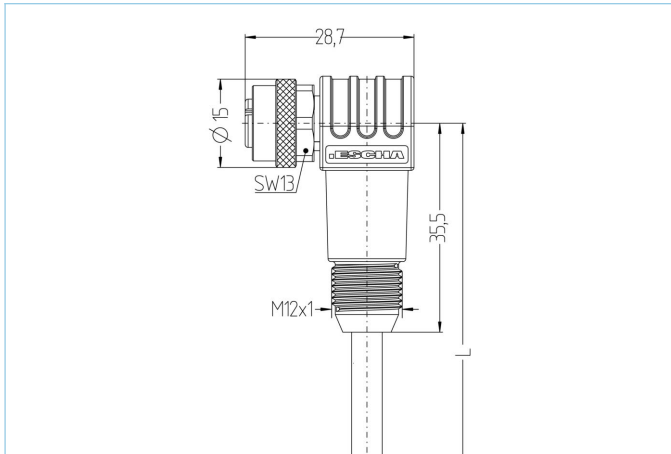

Product data

Item description	RA-WWAKG4.166-2/S4502
Item-No.	8117186
Length	2m
Customs tariff-No.	85444290
Step-File	RA-WWAKG4-L.stp
EAN	4047106325022

Technical data

Connector	female, angled, M12, grip body with thread
Number of pins	4
Pin assignment	1 WH 1, 2 WH 2, 3 WH 3, 4 WH 4
Coding	A
Rated voltage	250V
Current load per pin (at 40°C)	4A
Insulation resistance	$\geq 10^9 \Omega$
Resistance	$\leq 5 m\Omega$
Contact material	Metal, CuZn, gold-plated
Contact-carrier material	Plastic, PA, BK
Grip body material	Plastic, TPU, BK
Coupling nut material	Metal, CuZn, nickel-plated
Sealing (female) material	FPM/FKM
Standards	IEC 61076-2-101
Mechanical life-cycle	>100 mating cycles
Cable end assembly	open cable end
Degree of pollution	3
Style	angled

Advanced technical data rail approved

Standards	DIN EN 50155, DIN EN 45545-2
Shock & vibration	Class 1, Category B (DIN EN 61373)
Degree of protection (mounted)	IP67 (-30°C...+90°C), IP65 (-40°C...+90°C)
Temperature range	Tx (-40°C...+90°C)
Fire prevention according to	DIN EN 45545-2 HL1-3

Cable web **RADOX®, 4x1mm², S4502**

Halogen-free, electron-beam cross-linked cable with improved behaviour in case of fire, easy to strip, soldering resistant and flexible. The cable is intended for fixed, mechanically protected installation inside railway vehicles or for installation in applications where limited alternating bending stresses occur during operation. The cable fulfills the requirements according to EN 50306-4 and EN 45545-2 (HL1 - HL3). It is characterized by a wide temperature range and a high oil- and fuel resistance. RADOX® is a registered trademark of HUBER+SUHNER AG, Switzerland.

Outer diameter of jacket	5.7 mm
Cable-jacket material	RADOX® EM 104
Jacket color	BK, similar RAL9005
Wire cross-section	4 x 1 mm²
Wire insulation material	RADOX® EI 306
Wire colors	WH 1, WH 2, WH 3, WH 4
Wire structure	19 x 0,26 mm
Bending radius (fixed)	3xØ-cable
Bending radius (repeated)	4xØ-cable
Temperature range (fixed)	-40°C...+120°C
Fire prevention according to	DIN EN 45545-2 HL1-3, DIN 5510 fire prevention-levels 1-4, NF F16-101 category A1, A2, B
Halogen-free	Yes
Special features	increased thermal load, flame retardant, low emission of smoke, halogen free, oil- and fuel resistant, RoHs compliant

Classification

eCl@ss 6.0	27279218
eCl@ss 7.0	27279218
eCl@ss 8.0	27279218
eCl@ss 9.0	27060311
ETIM 5.0	EC001855
ETIM 6.0	EC001855

Accessories

Torque-wrench set https://www.escha.net/en/products/standard/accessories-for-connectivity/8055431
Cable Stripping Tool https://www.escha.net/en/products/standard/accessories-for-connectivity/8066215
Screw plug, M12 https://www.escha.net/en/products/standard/accessories-for-connectivity?p=1&o=3&n=15&f=812
Mounting-clip, M12 https://www.escha.net/en/products/standard/accessories-for-connectivity/8047660
Safety-clip, M12
Adapter piece, M12 https://www.escha.net/en/products/standard/accessories-for-connectivity/8081747
Protective hose https://www.escha.net/en/products/standard/accessories-for-connectivity/8081621