

M12, male, straight, 4 poles, D-coded, RJ45, male, straight, 4 poles, shielded, rail approved

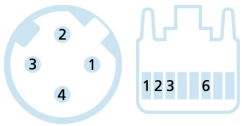
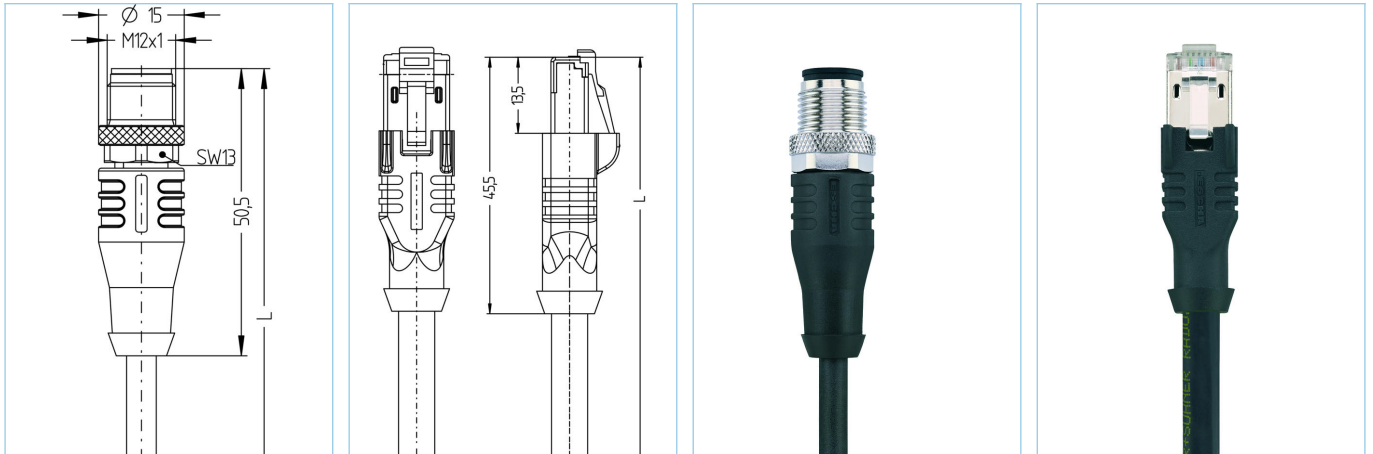

Product data

Item description	RA-WASSY4.029-0,5-RA-RJ45SS4.003/S4002
Item-No.	8114115
Length	0.5m
Customs tariff-No.	85444290
Step-File	RA-WASSY4_029-L-RA-RJ45SS4_003.stp
EAN	4047106314620

Technical data

	A-side	B-side
Connector	male, straight, M12	male, straight, RJ45
Number of pins	4	4
Pin assignment	1YE, 2 WH, 3 OG, 4 BU	1YE, 2 OG, 3 WH, 6 BU
Allocation		Industrial
Coding of	D	
Rated voltage	250V	60V
Current load (at 40°C)	4A	1A
Insulation resistance	$\geq 10^9 \Omega$	$\geq 10^9 \Omega$
Resistance	$\leq 5m\Omega$	$\leq 5m\Omega$
Transmission features	Cat5e	Cat5e
Contact material	Metal, CuZn, gold-plated	Metal, CuZn, gold-plated
Contact-carrier material	Plastic, PA, BK	Plastic
Grip body material	Plastic, TPU, BK	Plastic, TPE, BK
Coupling nut material	Metal, CuZn, nickel-plated	
Shielding	with shielding	with shielding
Material of shielding housing		Metal, CuZn, nickel-plated
Standards	IEC 61076-2-101	IEC 60603-7-5
Mechanical life-cycle	>100 mating cycles	>750 mating cycles
Degree of pollution	3	1

Advanced technical data rail approved

Standards	DIN EN 50155, DIN EN 45545-2
Shock & vibration	Class 1, Category B (DIN EN 61373)
Degree of protection (mounted)	IP67 (-30°C...+90°C), IP65 (-40°C...+90°C), IP20 (RJ45)
Temperature range	M12: Tx (-40°C...+90°C), RJ45 (-40°C...+70°C)
Fire prevention according to	DIN EN 45545-2 HL1-3, does not apply for RJ45

Cable web **Cat5, RADOX®, RW, 1x4xAWG22, S4002**

Halogen-free, electron-beam cross-linked Cat5-cable with improved fire performance. This cable can be used for fixed and protected installation inside of rail vehicles and busses and fulfills the requirements according to EN 45545-2 (HL1 - HL3). It is optimally suited for all Ethernet applications of class D (ECN) according to IEEE 802.3. For installation the guidelines of EN 50355 and EN 50343 must be considered. Due to its thin diameter, this cable is predestined for applications in which overmolded RJ45-connectors are used. RADOX® is a registered trademark of HUBER+SUHNER AG, Switzerland. RADOX® is a registered trademark of HUBER+SUHNER AG, Switzerland.

Outer diameter of jacket	6.60 mm
Cable-jacket material	RADOX® EM 104
Jacket color	BK
Wire cross-section	1 x 4 x AWG22, star quad
Wire insulation material	RADOX® FOAM
Wire colors	WH, BU, OG, YE
Bending radius (fixed)	6xØ cable
Temperature range (fixed)	-50°C...+90°C
Fire prevention according to	DIN EN 45545-2 HL1-3, DIN 5510 fire prevention-levels 1-4, NF F16-101 category A1, A2, B, UNI CEI 11170, danger level LR1-LR4, NFPA 130, UN ECE R 118
Shielding	Yes
Halogen-free	Yes
Transmission features	Cat5e
Special features	increased thermal load, flame retardant, low emission of smoke, halogen free, oil- and fuel resistant, RoHS compliant

Classification

eCl@ss 6.0	27060307
eCl@ss 7.0	27060307
eCl@ss 8.0	27060307
eCl@ss 9.0	27060307
ETIM 5.0	EC000830
ETIM 6.0	EC000830

Accessories

Torque-wrench set

<https://www.escha.net/en/products/standard/accessories-for-connectivity/8055431>

Unlocking clip for RJ45

<https://www.escha.net/en/products/standard/accessories-for-connectivity?p=1&o=3&n=15&f=807>

Marking rings Ø 9mm

<https://www.escha.net/en/products/standard/accessories-for-connectivity?p=1&o=3&n=15&f=809>

Screw cap, M12

<https://www.escha.net/en/products/standard/accessories-for-connectivity?p=1&o=3&n=15&f=811>

Mounting-clip, M12

<https://www.escha.net/en/products/standard/accessories-for-connectivity/8047660>

Safety-clip, M12