

## M12, female, angled, 5 poles, CANopen/DeviceNet

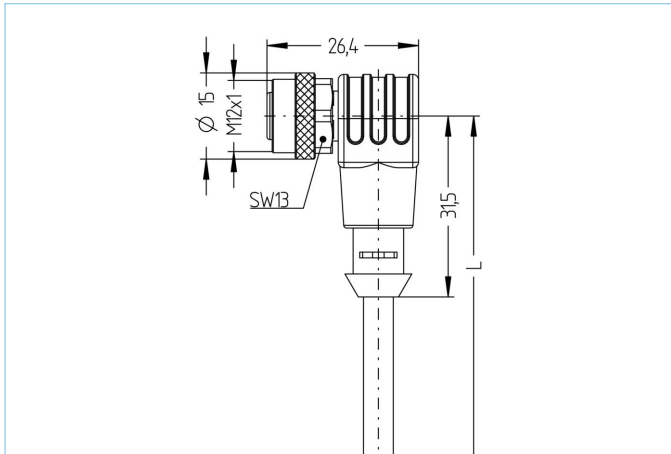

CANopen



Product data	
Item description	CD-WWAK5.022-4,5/52800
Item-No.	8111500
Length	4.5m
Customs tariff-No.	85444290
Step-File	CD-WWAK5-m.stp
EAN	4047106307929
Technical data	
Connector	female, angled, M12
Number of pins	5
Pin assignment	1 (GND), 2 RD (+), 3 BK (-), 4 WH (CAN_H), 5 BU (CAN_L)
Coding	A
Rated voltage	60V
Current load per pin (at 40°C)	4A
Insulation resistance	≥10 <sup>9</sup> Ω
Resistance	≤ 5mΩ
Ambient temperature product	-30°C...+90°C
Contact material	Metal, CuZn, gold-plated
Contact-carrier material	Plastic, TPU, BK
Grip body material	Plastic, TPU, BK
Coupling nut material	Metal, CuZn, nickel-plated
Sealing (female) material	FPM/FKM
Standards	IEC 61076-2-101
Degree of protection (mounted)	IP65, IP67, IP68
Mechanical life-cycle	>100 mating cycles
Cable end assembly	open cable end
Degree of pollution	3
Style	angled

<b>Cable web</b>	<b>PUR, UL, S2800, CANopen/DeviceNet</b>
------------------	--

UL- and CSA-listed shielded PUR-cable for automation technology. As a data transmitter, it supports CANopen as well as DeviceNetbased fieldbuses. High transmission rates enable transport of real-time data. Due to the constructive setup and the materials used, increased mechanical stresses (abrasion, bending, vibrations etc.) do not pose any restrictions to the application. Drag-chain application is possible. (>2.5million bending cycles).

Outer diameter of jacket	6.90 mm
Cable-jacket material	PUR
Jacket color	BK, similar RAL9005
Wire cross-section	2 x 0.25 mm <sup>2</sup> + 2 x 0.34 mm <sup>2</sup>
Wire insulation material	PE/PP
Wire colors	WH, BU, RD, BK
Wire structure	19 x 0.13mm (0.25mm <sup>2</sup> ), 19 x 0.15mm (0.34mm <sup>2</sup> )
Bending radius (fixed)	5 x Ø-cable
Bending radius (repeated)	10 x Ø-cable
Temperature range (repeated)	-25°C...+80°C
Temperature range (fixed)	-50°C...+80°C
Drag chain-application	>2.5Mio. cycles
Shielding	Yes, with stranded wire
Halogen-free	Yes
Rated voltage cable	≤300 V
Special features	flame retardant, halogen free, hydrolysis proof, LABS free, microbes resistant, oil resistant, ozone resistant, recyclable, RoHs compliant, acid- and alkali resistant, drag chain-adapted, seawater resistant, UV resistant

<b>Classification</b>	
-----------------------	--

eCl@ss 6.0	27279218
eCl@ss 7.0	27279218
eCl@ss 8.0	27279218
eCl@ss 9.0	27060311
ETIM 5.0	EC001855
ETIM 6.0	EC001855

<b>Accessories</b>
--------------------

<b>Mounting-clip, M12</b> <a href="https://www.escha.net/en/products/standard/accessories-for-connectivity/8047660">https://www.escha.net/en/products/standard/accessories-for-connectivity/8047660</a>
<b>Torque-wrench set</b> <a href="https://www.escha.net/en/products/standard/accessories-for-connectivity/8055431">https://www.escha.net/en/products/standard/accessories-for-connectivity/8055431</a>
<b>Marking rings Ø 9mm</b> <a href="https://www.escha.net/en/products/standard/accessories-for-connectivity?p=1&amp;o=3&amp;n=15&amp;f=809">https://www.escha.net/en/products/standard/accessories-for-connectivity?p=1&amp;o=3&amp;n=15&amp;f=809</a>
<b>Screw plug, M12</b> <a href="https://www.escha.net/en/products/standard/accessories-for-connectivity?p=1&amp;o=3&amp;n=15&amp;f=812">https://www.escha.net/en/products/standard/accessories-for-connectivity?p=1&amp;o=3&amp;n=15&amp;f=812</a>
<b>Cable Stripping Tool</b> <a href="https://www.escha.net/en/products/standard/accessories-for-connectivity/8066215">https://www.escha.net/en/products/standard/accessories-for-connectivity/8066215</a>
<b>Cable Stripping Tool</b> <a href="https://www.escha.net/en/products/standard/accessories-for-connectivity/8066216">https://www.escha.net/en/products/standard/accessories-for-connectivity/8066216</a>