

M12, female, straight, 4 poles, T-coded, M12, male, straight, 4 poles, T-coded, POWER

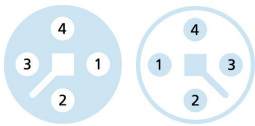
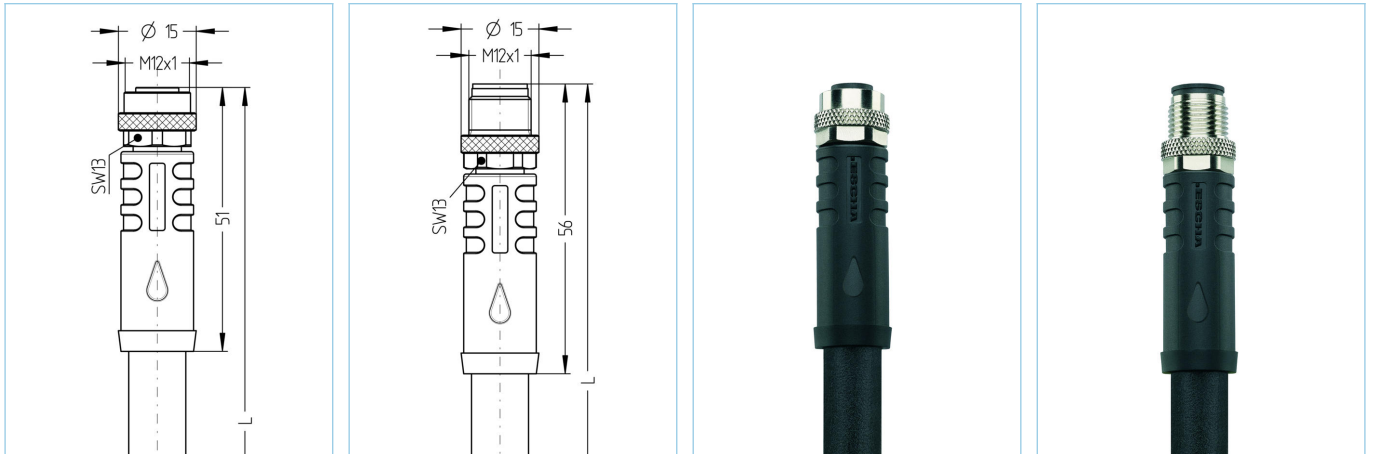

**Product data**

Item description	PT-AM12K4-0,5-PT-AM12S4/S5025
Item-No.	8111000
Length	0.5m
Customs tariff-No.	85444290
Step-File	PT-AM12K4-L-PT-AM12S4.stp
EAN	4047106306717

**Technical data**

	A-side	B-side
Connector	female, straight, M12	male, straight, M12
Number of pins	4	4
Pin assignment	1 BN, 2 WH, 3 BU, 4BK	1 BN, 2 WH, 3 BU, 4BK
Coding of	T	T
Rated voltage	63V <sub>DC</sub>	63V <sub>DC</sub>
Current load (at 40°C)	12A	12A
Insulation resistance	≥10 <sup>8</sup> Ω	≥10 <sup>8</sup> Ω
Ambient temperature product	-30°C...+90°C	-30°C...+90°C
Contact material	Metal, CuZn, gold-plated	Metal, CuZn, gold-plated
Contact-carrier material	Plastic, PA, BK	Plastic, PA, BK
Grip body material	Plastic, TPU, BK	Plastic, TPU, BK
Coupling nut material	Metal, CuZn, nickel-plated	Metal, CuZn, nickel-plated
Sealing (female) material	FPM/FKM	
Standards	IEC 61076-2-111	IEC 61076-2-111
Degree of protection (mounted)	IP65, IP67, IP68	IP65, IP67, IP68
Mechanical life-cycle	>100 mating cycles	>100 mating cycles
Degree of pollution	3	3

**Cable web** PUR, UL, S5015, 1,5mm<sup>2</sup>

High flexible and oil-resistant, halogen-free control cables for fixed-wired dynamic drag-chain applications with average loads. The PUR outer jacket is firm and resistant to high mechanical stresses like grinding or abrasion. They are adapted for applications in automation, load circuits of industrial machinery, automatic assembly- and placement machinery, especially in wet areas of machine tools and transfer lines. The cables meet the UL and CSA requirements.

Outer diameter of jacket	9.60 mm
Cable-jacket material	PUR
Jacket color	BK, similar RAL9005
Wire cross-section	4 x 1.5 mm <sup>2</sup>
Wire insulation material	PP
Wire colors	BN, WH, BU, BK
Wire structure	extra finely stranded class 6
Bending radius (fixed)	4 x Ø-cable
Bending radius (repeated)	7,5 x Ø-cable
Temperature range (repeated)	-25°C...+80°C
Temperature range (fixed)	-40°C...+80°C
Temperature range (UL repeated)	-40°C...+80°C
Temperature range (UL fixed)	-50°C...+80°C
Drag chain-application	>8 Mio. cycles
Halogen-free	Yes
Torsion	+/-270°/m, ≥ 1 Mio. cycles
Rated voltage cable	VDE U0/U: 600V/1000V
Special features	flame retardant, halogen free, high flexibility, LABS free, microbes resistant, oil resistant, ozone resistant, recyclable, RoHs compliant, acid- and alkali resistant, drag chain-adapted, welding sparks resistant, seawater resistant, UV resistant

**Derating curve according to DIN 60512-5-2**

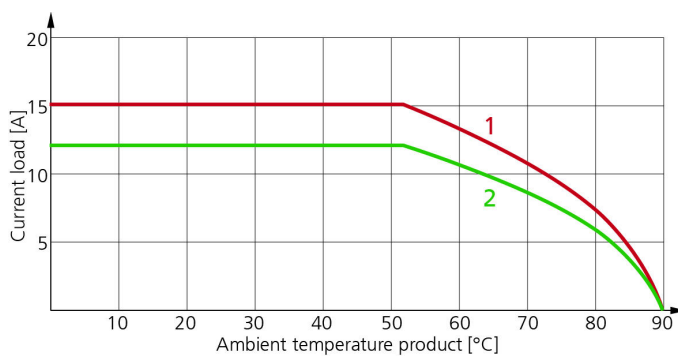

- 1: Base curve
- 2: Derived curve according to DIN 60512-5-2 with correction factor 0,8

**UL installation note**

[https://www.escha.net/media/pdf/ESCHA\\_Kundeninformation\\_M12x1\\_POWER\\_UL\\_2020.pdf](https://www.escha.net/media/pdf/ESCHA_Kundeninformation_M12x1_POWER_UL_2020.pdf)

**Classification**

eCl@ss 6.0	27279218
eCl@ss 7.0	27279218
eCl@ss 8.0	27279218
eCl@ss 9.0	27060311
ETIM 5.0	EC001855
ETIM 6.0	EC001855

## Accessories

### Mounting-clip, M12

<https://www.escha.net/en/products/standard/accessories-for-connectivity/8047660>

### Torque-wrench set

<https://www.escha.net/en/products/standard/accessories-for-connectivity/8055431>

### Marking rings Ø 9mm

<https://www.escha.net/en/products/standard/accessories-for-connectivity?p=1&o=3&n=15&f=809>

### Screw plug, M12

<https://www.escha.net/en/products/standard/accessories-for-connectivity?p=1&o=3&n=15&f=812>

### Screw cap, M12

<https://www.escha.net/en/products/standard/accessories-for-connectivity?p=1&o=3&n=15&f=811>