

RJ45, male, straight, 4 poles, shielded, Industrial Ethernet 100 MBit/s

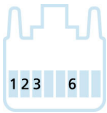
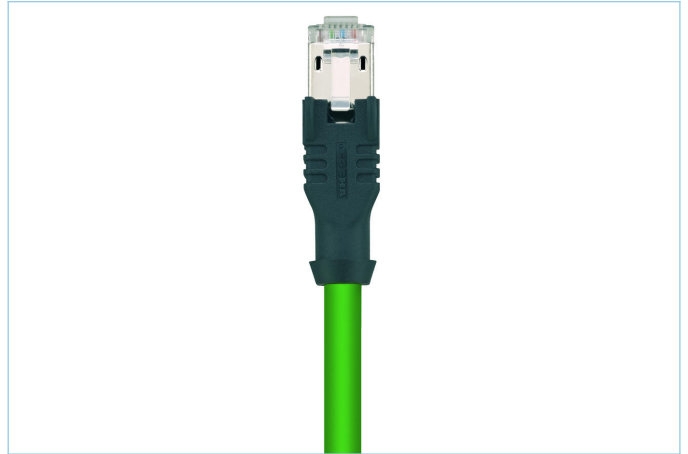
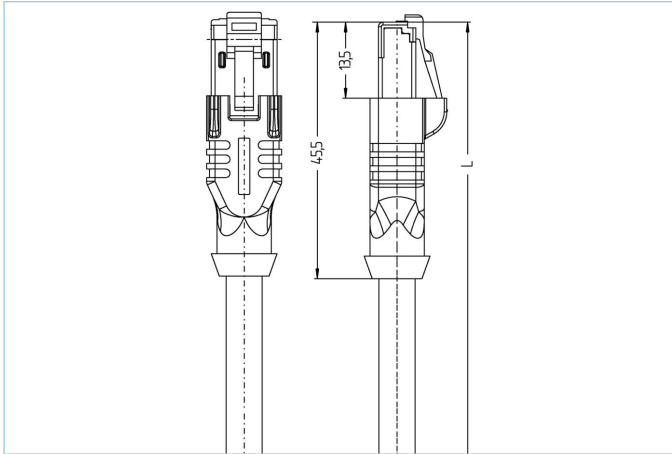

Product data	
Item description	IE-RJ45SS4.003-4/S2171
Item-No.	8102799
Length	4m
Customs tariff-No.	85444290
Step-File	IE-RJ45SS4_003.stp
EAN	4047106287528
Technical data	
Connector	male, straight, RJ45
Number of pins	4
Pin assignment	1 YE, 2 OG, 3 WH, 6 BU
Allocation	Industrial
Rated voltage	60V
Current load per pin (at 40°C)	1A
Insulation resistance	≥10 ⁹ Ω
Transmission features	Cat5e
Ambient temperature product	-40°C...+70°C
Contact material	Metal, CuSn, gold-plated
Contact-carrier material	Plastic, PA UL94-V0, transparent
Grip body material	Plastic, TPE, BK
Material of shielding housing	Metal, CuZn, nickel-plated
Shielding	with shielding
Standards	IEC 60603-7-5
Degree of protection (mounted)	IP20
Mechanical life-cycle	>750 mating cycles
Cable end assembly	open cable end
Degree of pollution	1
Style	straight

Advanced technical data UL

Rated voltage	50V _{AC/DC}
Rated current	1,0A

Cable web Cat5e, PUR, UL, S2171, PROFINET

Shielded, PUR-cable for industrial applications. The cable is CMX-verified or meets the Cat5e (electrical properties of EN 50288-2-1) requirements. Materials and a constructive setup allow for increased mechanical stresses (abrasion, bending, vibrations etc.) of the cable. A drag-chain application with up to 3 million bending cycles is possible.

Outer diameter of jacket	6.50 mm
Cable-jacket material	PUR
Jacket color	GN, similar RAL6018
Wire cross-section	1 x 4 x AWG22, star quad
Wire insulation material	FRNC
Wire colors	WH, BU, OG, YE
Wire structure	7 x 0.25 mm
Bending radius (fixed)	4 x Ø-cable
Bending radius (repeated)	8 x Ø-cable
Temperature range (repeated)	-30°C...+70°C
Temperature range (fixed)	-40°C...+75°C
Drag chain-application	3 Mio. bending cycles
Halogen-free	Yes
Transmission features	Cat5e
Rated voltage cable	600 V UL rating
Special features	flame retardant, halogen free, high flexibility, hydrolysis proof, LABS free, microbes resistant, oil resistant, ozone resistant, PROFINET Type C, recyclable, RoHs compliant, acid- and alkali resistant, drag chain-adapted, seawater resistant, UN ECE R 118, UV resistant

Classification

eCl@ss 6.0	27061801
eCl@ss 7.0	27060308
eCl@ss 8.0	27060308
eCl@ss 9.0	27060308
ETIM 5.0	EC002599
ETIM 6.0	EC002599