

M12, male, straight, 8 poles, X-coded, RJ45, male, straight, 8 poles, shielded, rail approved

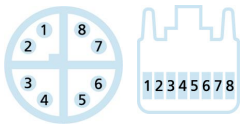
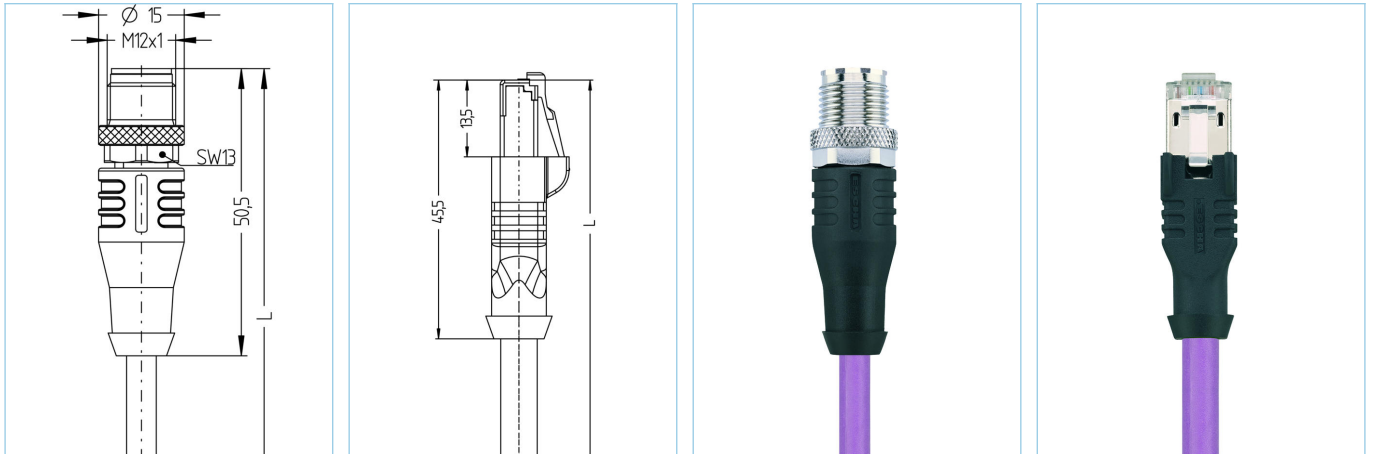

Product data	
Item description	RA-WASSX8.066-1-RA-RJ45SS8.002/S5006VT
Item-No.	8098663
Length	1m
Customs tariff-No.	85444290
Step-File	RA-WASSX8-L-RA-RJ45SS8_S5006.stp
EAN	4047106279912

Technical data	A-side	B-side
Connector	male, straight, M12	male, straight, RJ45
Number of pins	8	8
Pin assignment	1 WH, 2 OG; 3 WH, 4 GN; 5 WH, 6 BN; 7 WH, 8 BU	1 WH, 2 OG; 3 WH, 4 GN; 5 WH, 6 BN; 7 WH, 8 BU
Allocation		Industrial
Coding of	X	
Rated voltage	50V _{AC} 60V _{DC}	60V
Current load (at 40°C)	0.5A	1A
Insulation resistance	≥10 ⁸ Ω	≥10 ⁸ Ω
Resistance	≤ 5mΩ	≤ 5mΩ
Transmission features	Cat6A	Cat6A
Contact material	Metal, CuZn, gold-plated	Metal, CuZn, gold-plated
Grip body material	Plastic, TPU, BK	Plastic, TPE, BK
Shielding	with shielding	with shielding
Material of shielding housing		Metal, CuZn, nickel-plated
Standards	IEC 61076-2-109	IEC 60603-7-51
Mechanical life-cycle	>100 mating cycles	>750 mating cycles
Degree of pollution	2	1

Advanced technical data rail approved

Standards	DIN EN 50155, DIN EN 45545-2
Shock & vibration	Class 1, Category B (DIN EN 61373)
Degree of protection (mounted)	IP67 (-30°C...+90°C), IP65 (-40°C...+90°C), IP20 (RJ45)
Temperature range	M12: Tx (-40°C...+90°C), RJ45 (-40°C...+70°C)
Fire prevention according to	DIN EN 45545-2 HL1-3, does not apply for RJ45

Cable web **Cat7, BETAtrans®, RW, 4x2xAWG26/7, S5006VT**

Halogen-free, electron-beam cross-linked Cat7-data cable with improved fire performance. Excellent features regarding NEXT, attenuation and screening characteristics (pair- and overall screen). This cable can be used for fixed and protected installation inside of rail vehicles and busses and fulfills the requirements according to EN 45545-2 (HL1 - HL3). It is optimally suited for all Ethernet applications of classes D to F (ECN and ETB) according to IEEE 802.3. For installation the guidelines of EN 50355 and EN 50343 must be considered. Due to its thin diameter, this cable is predestined for applications in which overmolded, angled M12x1-connectors as well as overmolded RJ45-connectors are used. BETAtrans® is a registered trademark of LEONI Studer AG, Switzerland.

Outer diameter of jacket	6.60 mm
Cable-jacket material	BETAtrans® Polyolefin Copolymer
Jacket color	VT
Wire cross-section	4 x 2 x AWG26
Wire insulation material	BETAtrans® Cell PE
Wire colors	WH/OG, WH/GN, WH/BN, WH/BU
Wire structure	7 x 0.20 mm
Bending radius (fixed)	5 x Ø-cable
Bending radius (repeated)	6 x Ø-cable
Temperature range (fixed)	-40°C...+80°C
Fire prevention according to	DIN EN 45545-2 HL1-3, DIN 5510 fire prevention-levels 1-4, NF F16-101 category A1, A2, B, UNI CEI 11170, danger level LR1-LR4, NFPA 130, UN ECE R 118
Shielding	Yes
Halogen-free	Yes
Transmission features	Cat7
Rated voltage cable	125 VAC
Special features	increased thermal load, flame retardant, low emission of smoke, halogen free, LABS free, oil- and fuel resistant, RoHs compliant

Classification

eCl@ss 6.0	27060307
eCl@ss 7.0	27060307
eCl@ss 8.0	27060307
eCl@ss 9.0	27060307
ETIM 5.0	EC000830
ETIM 6.0	EC000830

Accessories

Torque-wrench set

<https://www.escha.net/en/products/standard/accessories-for-connectivity/8055431>

Dustproof-cap, RJ45

<https://www.escha.net/en/products/standard/accessories-for-connectivity/8064715>

Mounting-clip, M12

<https://www.escha.net/en/products/standard/accessories-for-connectivity/8047660>

Mounting-set, M12

<https://www.escha.net/en/products/standard/accessories-for-connectivity/8047664>

Safety-clip, M12

Screw cap, M12

<https://www.escha.net/en/products/standard/accessories-for-connectivity?p=1&o=3&n=15&f=811>

Unlocking clip for RJ45

<https://www.escha.net/en/products/standard/accessories-for-connectivity?p=1&o=3&n=15&f=807>

Marking rings Ø 9mm

<https://www.escha.net/en/products/standard/accessories-for-connectivity?p=1&o=3&n=15&f=809>