

Receptacle Double-ended cordset, M12, female, straight, 8 poles, X-coded, M12, male, straight, 8 poles, X-coded, shielded, Industrial Ethernet

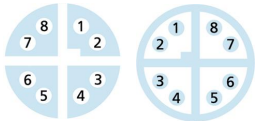
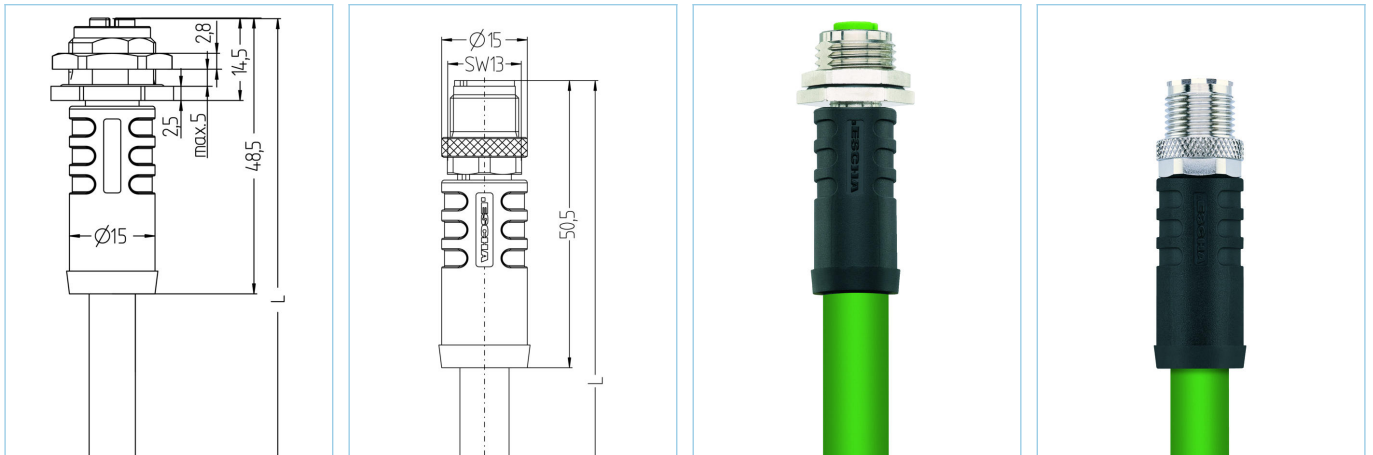

Product data		
Item description	IE-FKFDSX8.066-10-IE-WASSX8.066/S4031	
Item-No.	8094530	
Length	10m	
Customs tariff-No.	85444290	
Step-File	IE-FKFDSX8-L-IE-WASSX8_S403X.stp	
EAN	4047106268855	
Technical data	A-side	B-side
Connector	female, straight, M12	male, straight, M12
Number of pins	8	8
Pin assignment	1 WHOG, 2 OG; 3 WHGN, 4 GN; 5 WHBN, 6 BN; 7 WHBU, 8 BU	1 WHOG, 2 OG; 3 WHGN, 4 GN; 5 WHBN, 6 BN; 7 WHBU, 8 BU
Coding of	X	X
Rated voltage	50V _{AC} 60V _{DC}	50V _{AC} 60V _{DC}
Current load (at 40°C)	0.5A	0.5A
Insulation resistance	≥10 ⁹ Ω	≥10 ⁹ Ω
Transmission features	Cat6A	Cat6A
Ambient temperature product	-30°C...+90°C	-30°C...+90°C
Contact material	Metal, CuSn, gold-plated	Metal, CuSn, gold-plated
Contact-carrier material	Plastic, PA, GN	Plastic, PA, transparent
Grip body material	Plastic, TPU, BK	Plastic, TPU, BK
Coupling nut material	Metal, CuZn, nickel-plated	Metal, CuZn, nickel-plated
Receptacle housing material	Metal, CuZn, nickel-plated	
Sealing (female) material	FPM/FKM	
Material of external sealing	NBR	
Shielding	with shielding	with shielding
Mounting direction	Back wall-mounting (incl. Fixing screw)	
Fastening thread	PG9	

Standards	IEC 61076-2-109	IEC 61076-2-109
Degree of protection (mounted)	IP65, IP67, IP68	IP65, IP67, IP68
Mechanical life-cycle	>100 mating cycles	>100 mating cycles
Degree of pollution	2	2

Advanced technical data UL

Rated voltage	48V _{AC/DC}
Rated current	0,5A

Cable web

Cat6, PUR, UL, S4031, PROFINET

PROFINET 4x2xAWG26/19 Type C is a highly flexible-, high-speed data cable of transmission category Cat 6. The cable is halogenfree, flame-retardant, resistant to oil, and resistant to abrasion due to PUR-outer jacket. It is excellently adapted for applications in industrial areas. The high-grade shielding provides for a high data transmission safety in electromagnetically charged surroundings. It is adapted for flexible applications, especially in drag-chains or on permanently movable machine parts in dry and wet areas.

Outer diameter of jacket	7.80 mm
Cable-jacket material	PUR
Jacket color	GN, similar RAL6018
Wire cross-section	4 x 2 x AWG26/19
Wire insulation material	FRNC
Wire colors	WH/BU ; WH/OG ; WH/GN ; WH/BN
Wire structure	19 x 0.102 mm
Bending radius (fixed)	4 x Ø-cable
Bending radius (repeated)	7,5 x Ø-cable
Temperature range (repeated)	-30°C...+70°C
Temperature range (fixed)	-40°C...+80°C
Drag chain-application	4 Mio. cycles
Shielding	Yes
Halogen-free	Yes
Transmission features	Cat6
Rated voltage cable	100 V
Special features	flame retardant, halogen free, high flexibility, LABS free, oil resistant, ozone resistant, recyclable, RoHs compliant, drag chain-adapted, UV resistant

Classification

eCl@ss 6.0	27060307
eCl@ss 7.0	27060307
eCl@ss 8.0	27060307
eCl@ss 9.0	27060307
ETIM 5.0	EC000830
ETIM 6.0	EC000830

Accessories

Marking rings Ø 9mm

<https://www.escha.net/en/products/standard/accessories-for-connectivity?p=1&o=3&n=15&f=809>

Torque-wrench set

<https://www.escha.net/en/products/standard/accessories-for-connectivity/8055431>