

M12, female, straight, 3+PE, S-coded, rail approved

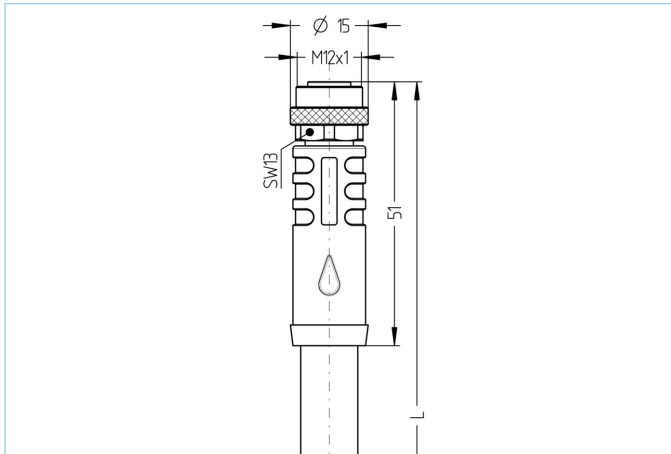

Product data

Item description	RA-PSAM12K4.189-4/S4600
Item-No.	8093422
Length	4m
Customs tariff-No.	85444290
Step-File	RA-PSAM12K4-m_S4600.stp
EAN	4047106265441

Technical data

Connector	female, straight, M12
Number of pins	3+PE
Pin assignment	1 WH, 2 WH, 3 WH, 4 GNYE
Coding	S
Rated voltage	630V _{AC} 600V _{AC} (UL)
Current load per pin (at 40°C)	12A
Insulation resistance	≥10 ⁹ Ω
Contact material	Metal, CuZn, gold-plated
Contact-carrier material	Plastic, PA, BK
Grip body material	Plastic, TPU, BK
Coupling nut material	Metal, CuZn, nickel-plated
Sealing (female) material	FPM/FKM
Standards	IEC 61076-2-111
Degree of protection (mounted)	IP65, IP67, IP68
Mechanical life-cycle	>100 mating cycles
Cable end assembly	open cable end
Degree of pollution	2
Style	straight

Advanced technical data rail approved

Standards	DIN EN 50155, DIN EN 45545-2
Shock & vibration	Class 1, Category B (DIN EN 61373)
Degree of protection (mounted)	IP67 (-30°C...+90°C), IP65 (-40°C...+90°C)
Temperature range	Tx (-40°C...+90°C)
Fire prevention according to	DIN EN 45545-2 HL1-3

Cable web **RADOX®, 4x1.5mm², S4600**

Halogen-free, electron-beam cross-linked cable with improved behaviour in case of fire, easy to strip, soldering resistant and flexible. The cable is intended for fixed, mechanically protected installation inside railway vehicles or for installation in applications where limited alternating bending stresses occur during operation. It fulfills the requirements according to EN 50306-4 and EN 45545-2 (HL1 - HL3). Wire cross-section: 1.5mm². RADOX® is a registered trademark of HUBER+SUHNER AG, Switzerland.

Outer diameter of jacket	6.7 mm
Cable-jacket material	RADOX® EM 104
Jacket color	BK, similar RAL9005
Wire cross-section	4 x 1.5 mm ²
Wire insulation material	RADOX® EI 306
Wire colors	WH 1, WH 2, WH 3, GNYE
Wire structure	19 x 0.31 mm
Bending radius (fixed)	3 x Ø-cable
Bending radius (repeated)	4 x Ø-cable
Temperature range (fixed)	-40°C...+120°C
Halogen-free	Yes
Rated voltage cable	VDE U0/U: 300V/500V
Special features	flame retardant, halogen free, high flexibility, LABS free, microbes resistant, oil resistant, oil- and fuel resistant, ozone resistant, recyclable, RoHS compliant, acid- and alkali resistant, drag chain-adapted, welding sparks resistant, seawater resistant, UV resistant

Accessories

Mounting-clip, M12

<https://www.escha.net/en/products/standard/accessories-for-connectivity/8047660>

Torque-wrench set

<https://www.escha.net/en/products/standard/accessories-for-connectivity/8055431>

Marking rings Ø 9mm

<https://www.escha.net/en/products/standard/accessories-for-connectivity?p=1&o=3&n=15&f=809>

Screw plug, M12

<https://www.escha.net/en/products/standard/accessories-for-connectivity?p=1&o=3&n=15&f=812>

Cable Stripping Tool

<https://www.escha.net/en/products/standard/accessories-for-connectivity/8066215>

Cable Stripping Tool

<https://www.escha.net/en/products/standard/accessories-for-connectivity/8066216>