

M12, female, straight, 3 poles, M12, male, straight, 3 poles, Food & Beverage

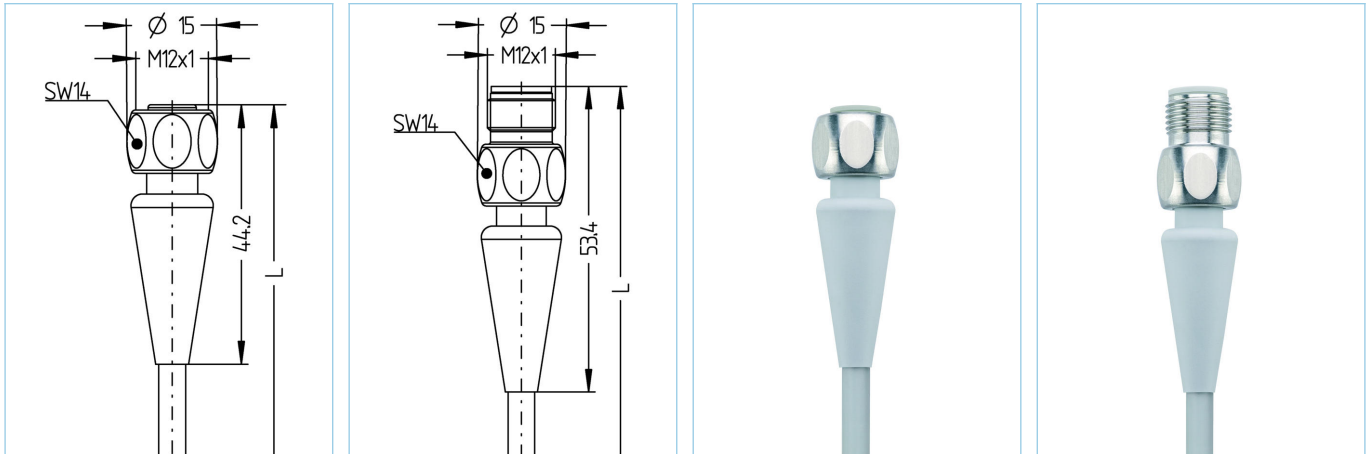

Product data	
Item description	FB-WAKH3-9,5-FB-WASH3/P01
Item-No.	8085150
Length	9.5m
Customs tariff-No.	85444290
Step-File	FB-WAKH3-L-FB-WASH3.stp
EAN	4047106243746

Technical data	A-side	B-side
Connector	female, straight, M12	male, straight, M12
Number of pins	3	3
Pin assignment	1 BN, 3 BU, 4 BK	1 BN, 3 BU, 4 BK
Coding of	A	A
Rated voltage	250V	250V
Current load (at 40°C)	4A	4A
Insulation resistance	$\geq 10^8 \Omega$	$\geq 10^8 \Omega$
Resistance	$\leq 5 m\Omega$	$\leq 5 m\Omega$
Ambient temperature product	-40°C...+105°C	-40°C...+105°C
Contact material	Metal, CuZn, gold-plated	Metal, CuZn, gold-plated
Contact-carrier material	Plastic, PP, GY	Plastic, PP, GY
Grip body material	Plastic, TPE, GY	Plastic, TPE, GY
Coupling nut material	Stainless steel, V4A	Stainless steel, V4A
Sealing (female) material	EPDM	
Standards	IEC 61076-2-101	IEC 61076-2-101
Degree of protection (mounted)	IP65, IP67, IP68, IP69	IP65, IP67, IP68, IP69
Mechanical life-cycle	>100 mating cycles	>100 mating cycles
Degree of pollution	3	3

Cable web	PVC, UL, P01, GY
------------------	-------------------------

PVC-cable for measurement and control-, and sensor technology. Suitable for applications in dry areas on packaging machines, assembly- and conveyor technology. High flexibility with unstressed movement (conditional drag-chain application possible). Predestined for applications in food- and beverage industry.

Outer diameter of jacket	4.60 mm
Cable-jacket material	PVC
Jacket color	GY, similar RAL7040
Wire cross-section	3 x 0.34 mm ²
Wire insulation material	PVC
Wire colors	BN, BU, BK
Wire structure	19 x 0.15 mm
Bending radius (fixed)	5 x Ø-cable
Bending radius (repeated)	10 x Ø-cable
Temperature range (repeated)	0°C...+80°C
Temperature range (fixed)	-25°C...+80°C
Rated voltage cable	≤300 V
Special features	good resistance against oils and chemicals, LABS free, ozone resistant, recyclable, RoHs compliant, acid- and alkali resistant, seawater resistant, UV resistant

Classification	
-----------------------	--

eCl@ss 6.0	27279218
eCl@ss 7.0	27279218
eCl@ss 8.0	27279218
eCl@ss 9.0	27060311
ETIM 5.0	EC001855
ETIM 6.0	EC001855

Accessories

Mounting-set, M12 https://www.escha.net/en/products/standard/accessories-for-connectivity/8047664
Torque-wrench set https://www.escha.net/en/products/standard/accessories-for-connectivity/8055431
Marking rings Ø 9mm https://www.escha.net/en/products/standard/accessories-for-connectivity?p=1&o=3&n=15&f=809
Food & Beverage, Adapter https://www.escha.net/en/products/standard/accessories-for-connectivity/8063392