

M12, female, straight, 4+FE, L-coded, M12, male, angled, 4+FE, L-coded, POWER

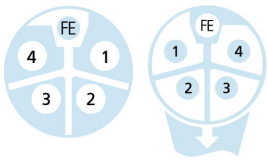
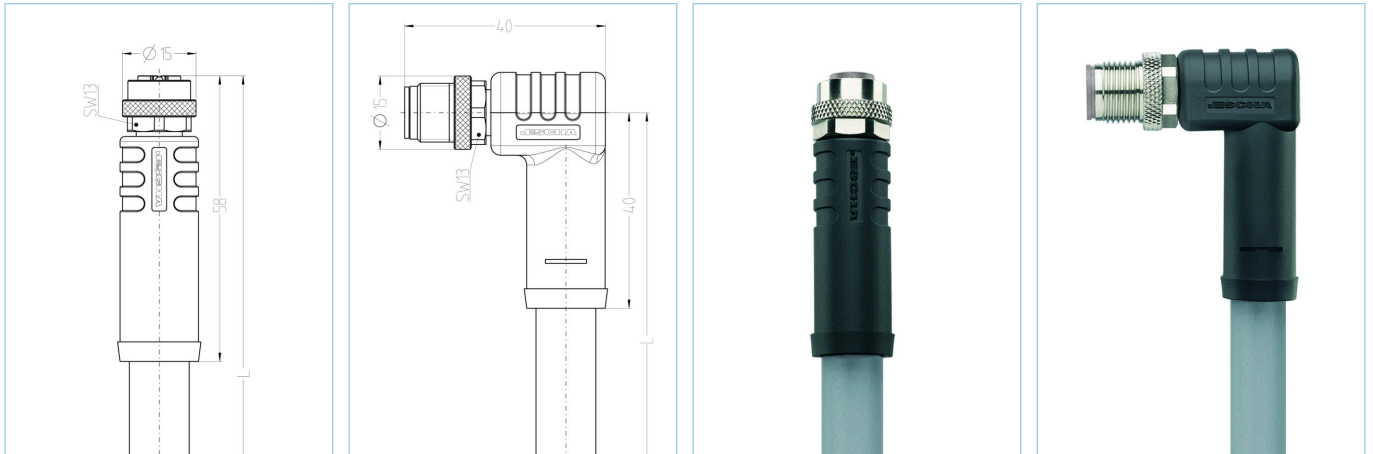

Product data	
Item description	PL-AM12K5.269-10-PL-WM12S5.269/S5025GY
Item-No.	8082326
Length	10m
Customs tariff-No.	85444290
EAN	4047106271978
Special	PNO compliant

Technical data	A-side	B-side
Connector	female, straight, M12	male, angled, M12
Number of pins	4+FE	4+FE
Pin assignment	1 BN, 2 WH, 3 BU, 4 BK, FE: GY	1 BN, 2 WH, 3 BU, 4 BK, FE: GY
Coding of	L	L
Rated voltage	63V _{DC}	63V _{DC}
Current load (at 40°C)	16A	16A
Insulation resistance	≥10 ⁸ Ω	≥10 ⁸ Ω
Ambient temperature product	-30°C...+90°C	-30°C...+90°C
Contact material	Metal, CuZn, gold-plated	Metal, CuZn, gold-plated
Contact-carrier material	Plastic, PA, GY	Plastic, PA, GY
Grip body material	Plastic, TPU, BK	Plastic, TPU, BK
Coupling nut material	Metal, CuZn, nickel-plated	Metal, CuZn, nickel-plated
Sealing (female) material	FPM/FKM	
Standards	IEC 61076-2-111	IEC 61076-2-111
Degree of protection (mounted)	IP65, IP67, IP68	IP65, IP67, IP68
Mechanical life-cycle	>100 mating cycles	>100 mating cycles
Degree of pollution	3	3

Cable web PUR, UL, S5025GY, 2,5mm²

High flexible and oil-resistant, halogen-free control cables for fixed-wired dynamic drag-chain applications with average loads. The PUR outer jacket is firm and resistant to high mechanical stresses like grinding or abrasion. They are adapted for applications in automation, load circuits of industrial machinery, automatic assembly- and placement machinery, especially in wet areas of machine tools and transfer lines. The cables meet the UL and CSA requirements.

Outer diameter of jacket	11.70 mm
Cable-jacket material	PUR
Jacket color	GY, similar RAL7040
Wire cross-section	5 x 2.5 mm ²
Wire insulation material	PP
Wire colors	BN, WH, BU, BK, GY
Wire structure	extra finely stranded class 6
Bending radius (fixed)	4 x Ø-cable
Bending radius (repeated)	7,5 x Ø-cable
Temperature range (repeated)	-25°C...+80°C
Temperature range (fixed)	-40°C...+80°C
Temperature range (UL repeated)	-40°C...+80°C
Drag chain-application	> 8 Mio. cycles
Halogen-free	Yes
Torsion	+/-270°/m, ≥ 1 Mio. cycles
Rated voltage cable	VDE U0/U: 600V/1000V
Special features	flame retardant, halogen free, high flexibility, LABS free, microbes resistant, oil resistant, ozone resistant, recyclable, RoHs compliant, acid- and alkali resistant, drag chain-adapted, welding sparks resistant, seawater resistant, UV resistant

Derating curve according to DIN 60512-5-2

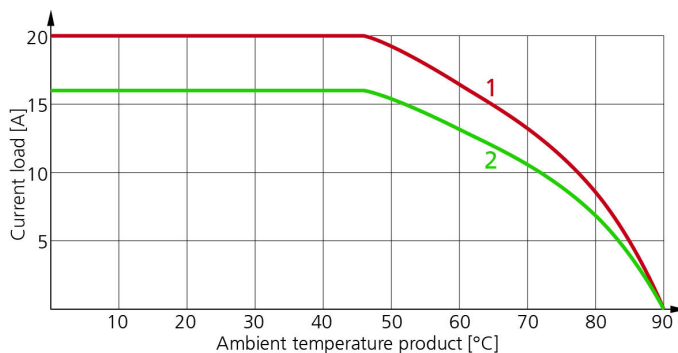

- 1: Base curve
- 2: Derived curve according to DIN 60512-5-2 with correction factor 0,8

Classification

eCl@ss 6.0	27279218
eCl@ss 7.0	27279218
eCl@ss 8.0	27279218
eCl@ss 9.0	27060311
ETIM 5.0	EC001855
ETIM 6.0	EC001855

Accessories

Mounting-clip, M12

<https://www.escha.net/en/products/standard/accessories-for-connectivity/8047660>

Torque-wrench set

<https://www.escha.net/en/products/standard/accessories-for-connectivity/8055431>

Marking rings Ø 9mm

<https://www.escha.net/en/products/standard/accessories-for-connectivity?p=1&o=3&n=15&f=809>

Screw plug, M12

<https://www.escha.net/en/products/standard/accessories-for-connectivity?p=1&o=3&n=15&f=812>

Screw cap, M12

<https://www.escha.net/en/products/standard/accessories-for-connectivity?p=1&o=3&n=15&f=811>