

M12, female, angled, 4 poles, D-coded, M12, male, straight, 4 poles, D-coded, shielded, Industrial Ethernet 100 MBit/s

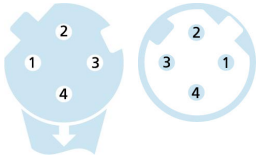
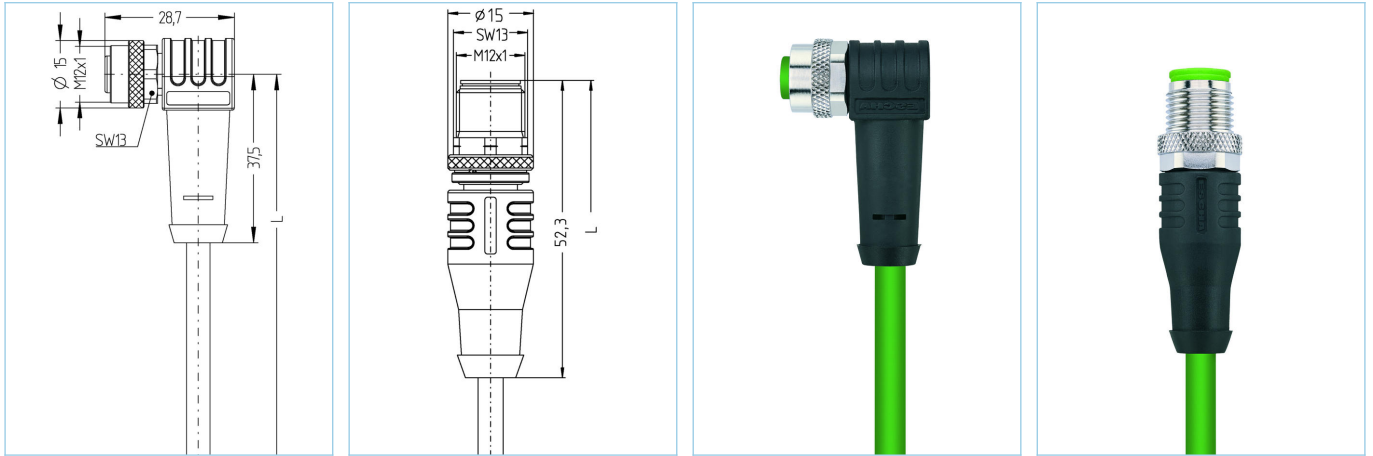

Product data		
Item description	IE-WWAKSY4.082-5-IE-WASSY4.082/S3400	
Item-No.	8079736	
Length	5m	
Customs tariff-No.	85444290	
EAN	4047106206376	
Technical data	A-side	B-side
Connector	female, angled, M12	male, straight, M12
Number of pins	4	4
Pin assignment	1 WH/OG, 2 WH/BU, 3 OG, 4 BU	1 WH/OG, 2 WH/BU, 3 OG, 4 BU
Coding of	D	D
Rated voltage	250V	250V
Current load (at 40°C)	4A	4A
Insulation resistance	≥10 ⁹ Ω	≥10 ⁹ Ω
Ambient temperature product	-30°C...+90°C	-30°C...+90°C
Contact material	Metal, CuSn, gold-plated	Metal, CuSn, gold-plated
Contact-carrier material	Plastic, TPU, GN	Plastic, TPU, GN
Grip body material	Plastic, TPU, BK	Plastic, TPU, BK
Coupling nut material	Metal, CuZn, nickel-plated	Metal, CuZn, nickel-plated
Sealing (female) material	FPM/FKM	
Shielding	with shielding	with shielding
Standards	IEC 61076-2-101	IEC 61076-2-101
Degree of protection (mounted)	IP65, IP67, IP68	IP65, IP67, IP68
Mechanical life-cycle	>100 mating cycles	>100 mating cycles
Degree of pollution	3	3

Cable web

Cat5e, PUR, UL, S3400

Shielded PUR Ethernet-cable for industrial applications. Fits to real-time requirements according to IEC61158. The cable meets the UL-Style 21815 (80°/300V)- and the Cat5 (electrical properties according to EN50288-2-2) requirements. Materials and a constructive setup for increased mechanical stresses (abrasion, bending, vibrations etc.) of the cable. Drag-chain/torsion operations are possible. High tensile strength through incorporated Kevlar-strands.

Outer diameter of jacket	4.80 mm
Cable-jacket material	PUR
Jacket color	GN, similar RAL6018
Wire cross-section	1 x 4 x AWG26, star quad
Wire insulation material	PP
Wire colors	WHBU/BU, WHOG/OG
Wire structure	19 x 0.10 mm
Bending radius (fixed)	4 x Ø-cable
Bending radius (repeated)	7,5 x Ø-cable
Temperature range (repeated)	-30°C...+70°C
Temperature range (fixed)	-40°C...+80°C
Transmission features	Cat5
Rated voltage cable	300 V UL rating
Special features	halogen free, high flexibility, hydrolysis proof, LABS free, microbes resistant, oil resistant, ozone resistant, recyclable, RoHs compliant, acid- and alkali resistant, drag chain-adapted, seawater resistant, UV resistant

Accessories

Mounting-clip, M12

<https://www.escha.net/en/products/standard/accessories-for-connectivity/8047660>

Torque-wrench set

<https://www.escha.net/en/products/standard/accessories-for-connectivity/8055431>

Marking rings Ø 9mm

<https://www.escha.net/en/products/standard/accessories-for-connectivity?p=1&o=3&n=15&f=809>

Screw plug, M12

<https://www.escha.net/en/products/standard/accessories-for-connectivity?p=1&o=3&n=15&f=812>

Screw cap, M12

<https://www.escha.net/en/products/standard/accessories-for-connectivity?p=1&o=3&n=15&f=811>