

M12, male, straight, 8 poles, X-coded, RJ45, male, straight, 8 poles, shielded, Industrial Ethernet 10 GBit/s

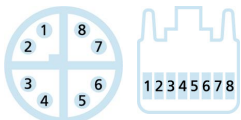

PROFI
NET

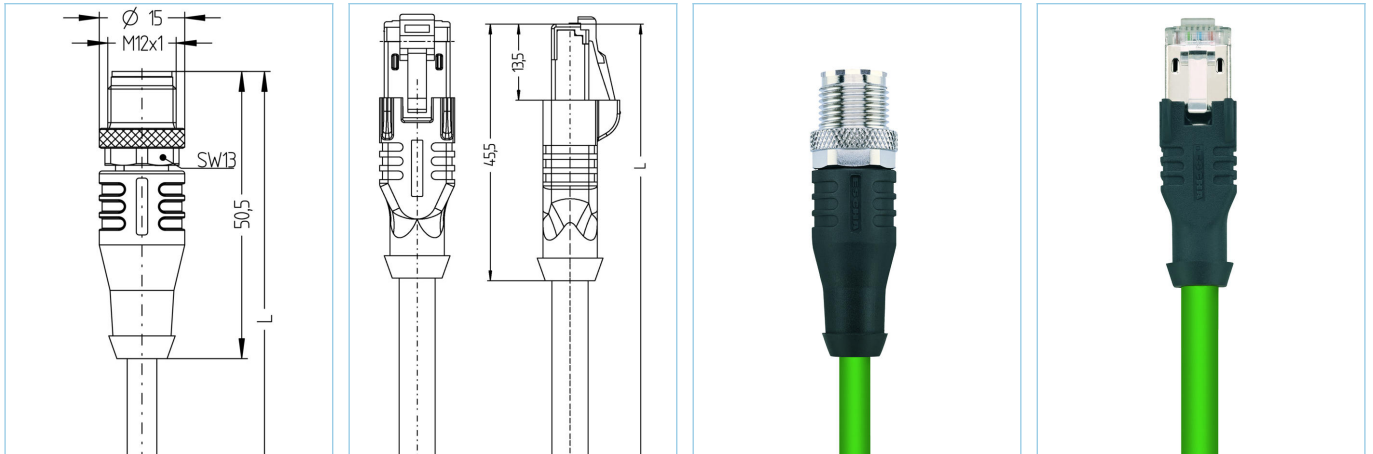

Product data

Item description	IE-WASSX8.066-2,5-IE-RJ45SS8.002/S3500
Item-No.	8079329
Length	2.5m
Customs tariff-No.	85444290
Step-File	IE-WASSX8-L-IE-RJ45SS8_S3500.stp
EAN	4047106214012

Technical data	A-side	B-side
Connector	male, straight, M12	male, straight, RJ45
Number of pins	8	8
Pin assignment	1 WHOG, 2 OG; 3 WHGN, 4 GN; 5 WHBN, 6 BN; 7 WHBU, 8 BU	1 WHOG, 2 OG; 3 WHGN, 4 BU; 5 WHBU, 6 GN; 7 WHBN, 8 BN
Allocation		T568B
Coding of	X	
Rated voltage	50V _{AC} 60V _{DC}	60V
Current load (at 40°C)	0.5A	1A
Insulation resistance	≥10 ⁸ Ω	≥10 ⁸ Ω
Transmission features	Cat6A	Cat6A
Ambient temperature product	-30°C...+90°C	-40°C...+70°C
Contact material	Metal, CuZn, gold-plated	Metal, CuSn, gold-plated
Contact-carrier material	Plastic, PA	Plastic
Grip body material	Plastic, TPU, BK	Plastic, TPE, BK
Coupling nut material	Metal, CuZn, nickel-plated	
Shielding	with shielding	with shielding
Material of shielding housing		Metal, CuZn, nickel-plated
Standards	IEC 61076-2-109	IEC 60603-7-51
Degree of protection (mounted)	IP65, IP67, IP68	IP20
Mechanical life-cycle	>100 mating cycles	>750 mating cycles
Degree of pollution	2	1

Advanced technical data UL

Rated voltage	30V _{AC/DC}
Rated current	0,5A

Cable web Cat7, PUR, UL, S3500

Shielded PUR-cable for industrial applications. The cable meets the UL-Style 20963 and the Cat7 (electrical properties according to EN50288-4-2) requirements. Materials and a constructive setup allow for increased mechanical stresses (abrasion, bending, vibrations etc.) of the cable.

Outer diameter of jacket	6.40 mm
Cable-jacket material	PUR
Jacket color	GN, similar RAL6018
Wire cross-section	4 x 2 x 0.14 mm ²
Wire insulation material	PE
Wire colors	WH/OG ; WH/GN ; WH/BN ; WH/BU
Wire structure	7 x 0.16 mm
Bending radius (fixed)	5 x Ø-cable
Bending radius (repeated)	10 x Ø-cable
Temperature range (repeated)	-20°C...+60°C
Temperature range (fixed)	-40°C...+80°C
Shielding	Yes
Halogen-free	Yes
Transmission features	Cat7
Rated voltage cable	30 V UL rating
Special features	halogen free, high flexibility, hydrolysis proof, no fire propagation, no corrosive gases, LABS free, microbes resistant, oil resistant, recyclable, RoHS compliant, acid- and alkali resistant, seawater resistant, UV resistant

Classification

eCl@ss 6.0	27060307
eCl@ss 7.0	27060307
eCl@ss 8.0	27060307
eCl@ss 9.0	27060307
ETIM 5.0	EC000830
ETIM 6.0	EC000830

Accessories

Unlocking clip for RJ45

<https://www.escha.net/en/products/standard/accessories-for-connectivity?p=1&o=3&n=15&f=807>

Marking rings Ø 9mm

<https://www.escha.net/en/products/standard/accessories-for-connectivity?p=1&o=3&n=15&f=809>

Screw cap, M12

<https://www.escha.net/en/products/standard/accessories-for-connectivity?p=1&o=3&n=15&f=811>