

M12, male, angled, 4 poles, D-coded, RJ45, male, straight, 4 poles, shielded, Industrial Ethernet 100 MBit/s

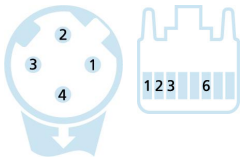
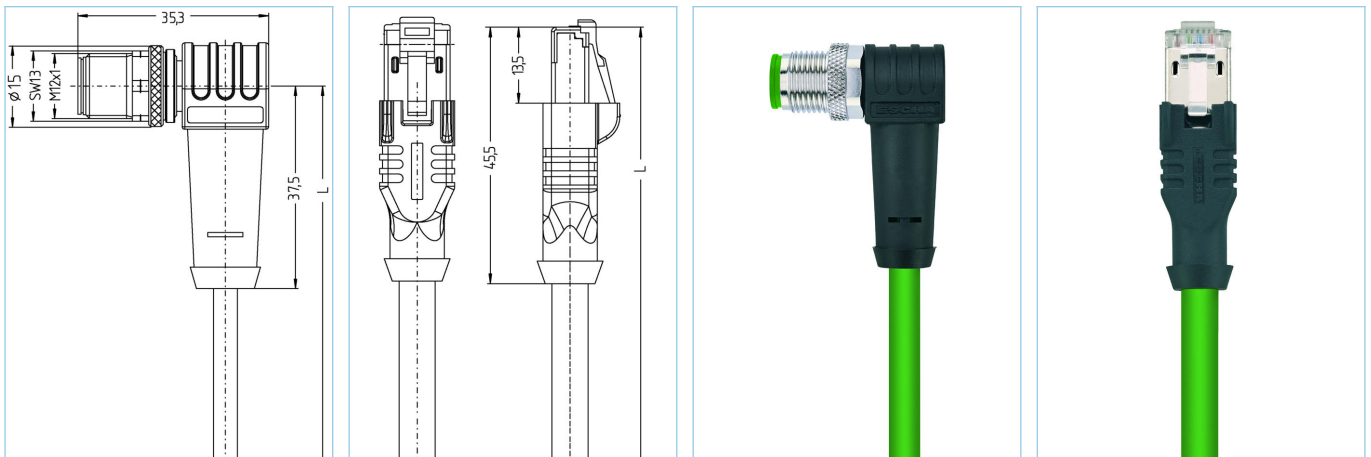

Product data

Item description	IE-WWASSY4.057-1-IE-RJ45SS4.003/S2171
Item-No.	8079310
Length	1m
Customs tariff-No.	85444290
EAN	4047106225230

Technical data

	A-side	B-side
Connector	male, angled, M12	male, straight, RJ45
Number of pins	4	4
Pin assignment	1 WH, 2 YE, 3 BU, 4 OG	1 YE, 2 OG, 3 WH, 6 BU
Allocation		Industrial
Coding of	D	
Rated voltage	250V	60V
Current load (at 40°C)	4A	1A
Insulation resistance	$\geq 10^8 \Omega$	$\geq 10^8 \Omega$
Ambient temperature product	-30°C...+90°C	-40°C...+70°C
Contact material	Metal, CuSn, gold-plated	Metal, CuZn, gold-plated
Contact-carrier material	Plastic, TPU, GN	Plastic
Grip body material	Plastic, TPU, BK	Plastic, TPE, BK
Coupling nut material	Metal, CuZn, nickel-plated	
Shielding	with shielding	with shielding
Standards	IEC 61076-2-101	IEC 60603-7-5
Degree of protection (mounted)	IP65, IP67, IP68	IP20
Mechanical life-cycle	>100 mating cycles	>750 mating cycles
Degree of pollution	3	1

Cable web
Cat5e, PUR, UL, S2171, PROFINET

Shielded, PUR-cable for industrial applications. The cable is CMX-verified or meets the Cat5e (electrical properties of EN 50288-2-1) requirements. Materials and a constructive setup allow for increased mechanical stresses (abrasion, bending, vibrations etc.) of the cable. A drag-chain application with up to 3 million bending cycles is possible.

Outer diameter of jacket	6.50 mm
Cable-jacket material	PUR
Jacket color	GN, similar RAL6018
Wire cross-section	1 x 4 x AWG22, star quad
Wire insulation material	FRNC
Wire colors	WH, BU, OG, YE
Wire structure	7 x 0.25 mm
Bending radius (fixed)	4 x Ø-cable
Bending radius (repeated)	8 x Ø-cable
Temperature range (repeated)	-30°C...+70°C
Temperature range (fixed)	-40°C...+75°C
Drag chain-application	3 Mio. bending cycles
Acceleration Drag chain	max. 4m/s ²
Halogen-free	Yes
Transmission features	Cat5e
Rated voltage cable	600 V UL rating
Special features	flame retardant, halogen free, high flexibility, hydrolysis proof, LABS free, microbes resistant, oil resistant, ozone resistant, PROFINET Type C, recyclable, RoHS compliant, acid- and alkali resistant, drag chain-adapted, seawater resistant, UN ECE R 118, UV resistant
Geschwindigkeit Schleppkette	max. 4m/s

Accessories
Marking rings Ø 9mm
<https://www.escha.net/en/products/standard/accessories-for-connectivity?p=1&o=3&n=15&f=809>
Unlocking clip for RJ45
<https://www.escha.net/en/products/standard/accessories-for-connectivity?p=1&o=3&n=15&f=807>
Screw cap, M12
<https://www.escha.net/en/products/standard/accessories-for-connectivity?p=1&o=3&n=15&f=811>
Mounting-clip, M12
<https://www.escha.net/en/products/standard/accessories-for-connectivity/8047660>