

M12, female, straight, 12 poles, M12, male, straight, 12 poles, shielded, sensor-/actuator cable

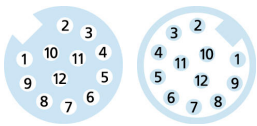
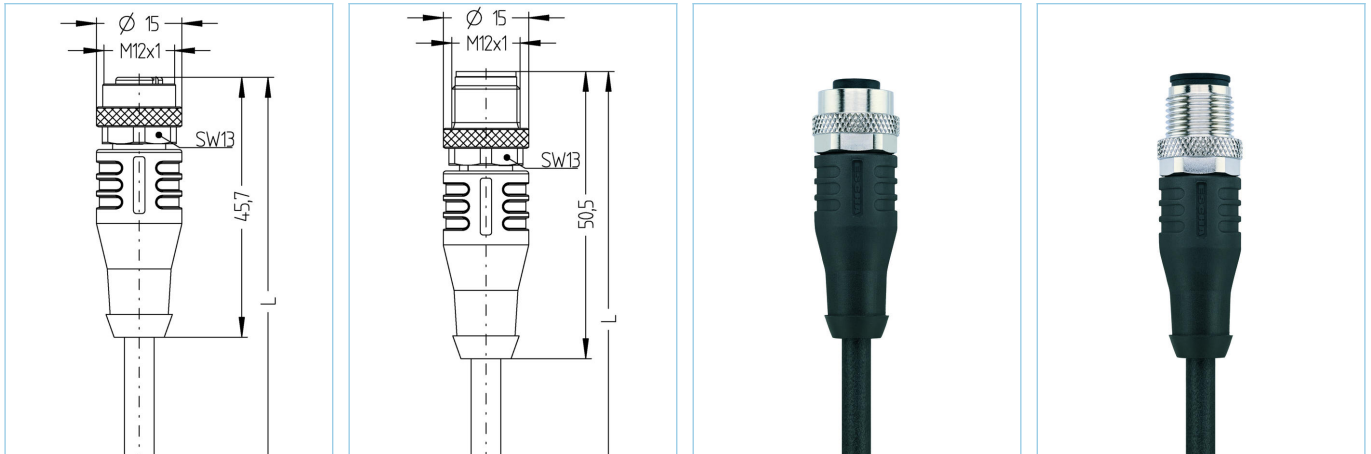

Product data	
Item description	AL-WAKS12-7-AL-WASS12/S370
Item-No.	8077962
Length	7m
Customs tariff-No.	85444290
Step-File	AL-WAKS12-m-AL-WASS12.stp
EAN	4047106207656

Technical data	A-side	B-side
Connector	female, straight, M12	male, straight, M12
Number of pins	12	12
Pin assignment	1 BN, 2 BU, 3 WH, 4 GN, 5 PK, 6 YE, 7 BK, 8 GY, 9 RD, 10 VT, 11 GYPK, 12 RDBU	1 BN, 2 BU, 3 WH, 4 GN, 5 PK, 6 YE, 7 BK, 8 GY, 9 RD, 10 VT, 11 GYPK, 12 RDBU
Coding of	A	A
Rated voltage	30V	30V
Current load (at 40°C)	1.5A	1.5A
Insulation resistance	$\geq 10^9 \Omega$	$\geq 10^9 \Omega$
Resistance	$\leq 5 m\Omega$	$\leq 5 m\Omega$
Ambient temperature product	-30°C...+90°C	-30°C...+90°C
Contact material	Metal, CuZn, gold-plated	Metal, CuZn, gold-plated
Contact-carrier material	Plastic, TPU, BK	Plastic, TPU, BK
Grip body material	Plastic, TPU, BK	Plastic, TPU, BK
Coupling nut material	Metal, CuZn, nickel-plated	Metal, CuZn, nickel-plated
Sealing (female) material	FPM/FKM	
Shielding	with shielding	with shielding
Standards	IEC 61076-2-101	IEC 61076-2-101
Degree of protection (mounted)	IP65, IP67, IP68	IP65, IP67, IP68
Mechanical life-cycle	>100 mating cycles	>100 mating cycles
Degree of pollution	3	3

Cable web	PUR, UL, S370
------------------	----------------------

Flexible, silicone- and halogen-free control cable with high mechanical strength. The cable is chemicals, hydrolysis-, and microbes-resistant. The drag-chain application is possible at a bending radius of minimum $10 \times d$. Due to its weld-field immunity, the cable is very well suited for the flexible application in robotics, machine-tool, and metal-cutting production. The cables meet the UL and CSA (UL10493/20549; cULus) requirements. Very good EMC-features with shielded versions.

Outer diameter of jacket	6.00 mm
Cable-jacket material	PUR
Jacket color	BK, similar RAL9005
Wire cross-section	12 x 0.14 mm ²
Wire insulation material	PP
Wire colors	BN, BU, WH, GN, PK, YE, BK, GY, RD, VT, GYPK, RDBU
Wire structure	18 x 0.10 mm
Bending radius (fixed)	5 x Ø-cable
Bending radius (repeated)	12 x Ø-cable
Temperature range (repeated)	-30°C...+90°C
Temperature range (fixed)	-40°C...+90°C
Temperature range (drag chain)	-25°C...+60°C
Drag chain-application	≥2 Mio. cycles
Shielding	Yes
Halogen-free	Yes
Torsion	+/-180°/m, ≥ 0.5 Mio. cycles
Rated voltage cable	≤300 V
Special features	flame retardant, halogen free, hydrolysis proof, LABS free, oil resistant, ozone resistant, recyclable, RoHs compliant, acid- and alkali resistant, drag chain-adapted, welding sparks resistant, seawater resistant, silicone free, torsion resistant, UV resistant

Classification	
-----------------------	--

eCl@ss 6.0	27279218
eCl@ss 7.0	27279218
eCl@ss 8.0	27279218
eCl@ss 9.0	27060311
ETIM 5.0	EC001855
ETIM 6.0	EC001855

Accessories	
--------------------	--

Mounting-clip, M12 https://www.escha.net/en/products/standard/accessories-for-connectivity/8047660	
---	--

Torque-wrench set https://www.escha.net/en/products/standard/accessories-for-connectivity/8055431	
--	--

Marking rings Ø 9mm https://www.escha.net/en/products/standard/accessories-for-connectivity?p=1&o=3&n=15&f=809	
--	--

Screw plug, M12 https://www.escha.net/en/products/standard/accessories-for-connectivity?p=1&o=3&n=15&f=812	
--	--

Screw cap, M12 https://www.escha.net/en/products/standard/accessories-for-connectivity?p=1&o=3&n=15&f=811	
---	--