

## M12, female, straight, 5 poles, sensor-/actuator cable, high-temperature

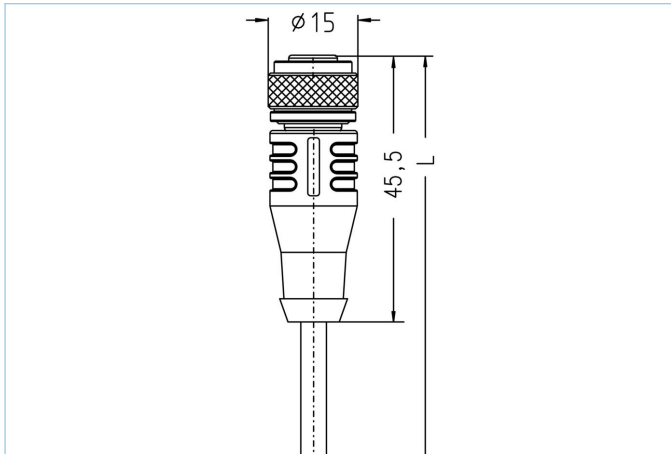

### Product data

Item description	HT-WAK4.5-8/S2430
Item-No.	8077689
Length	8m
Customs tariff-No.	85444290
Step-File	HT-WAK4_5.stp
EAN	4047106219000

### Technical data

Connector	female, straight, M12
Number of pins	5
Pin assignment	1 BN, 2 WH, 3 BU, 4 BK, 5 GY
Coding	A
Rated voltage	60V
Current load per pin (at 40°C)	4A
Insulation resistance	$\geq 10^9 \Omega$
Ambient temperature product	-20°C...+150°C
Contact material	Metal, CuZn, gold-plated
Contact-carrier material	Plastic, PBT GF, BK
Grip body material	Plastic, PBT GF, BK
Coupling nut material	Metal, CuZn, nickel-plated
Sealing (female) material	FPM/FKM
Standards	IEC 61076-2-101
Degree of protection (mounted)	IP65
Mechanical life-cycle	>100 mating cycles
Cable end assembly	50mm stripped
Degree of pollution	3
Style	straight

<b>Cable web</b>	<b>PTFE, S2430, high temp</b>
------------------	-------------------------------

The thermal resistance of this high-temperature cable extends from -190°C to +260°C. In addition, it stands out through a very good chemical strength, as well as its ozone- and weather resistance.

Outer diameter of jacket	3.80 mm
Cable-jacket material	PTFE
Jacket color	WH, similar RAL9003
Wire cross-section	5 x AWG22
Wire insulation material	PTFE
Wire colors	BN, WH, BU, BK, GY
Wire structure	7 x 0.254 mm
Bending radius (fixed)	5 x Ø-cable
Bending radius (repeated)	10 x Ø-cable
Temperature range (fixed)	-190°C...+260°C
Rated voltage cable	≤250 V
Special features	low emission of smoke, excellent chemicals resistance, hydrolysis proof, LABS free, non-flammable, ozone resistant, RoHs compliant, seawater resistant, UV resistant, flexibility at low temperature, flexible at high temperatures

<b>Classification</b>
-----------------------

eCl@ss 6.0	27279218
eCl@ss 7.0	27279218
eCl@ss 8.0	27279218
eCl@ss 9.0	27060311
ETIM 5.0	EC001855
ETIM 6.0	EC001855

<b>Accessories</b>
--------------------

Mounting-set, M12  
<https://www.escha.net/en/products/standard/accessories-for-connectivity/8047664>

Torque-wrench set  
<https://www.escha.net/en/products/standard/accessories-for-connectivity/8055431>

Marking rings Ø 9mm  
<https://www.escha.net/en/products/standard/accessories-for-connectivity?p=1&o=3&n=15&f=809>

Cable Stripping Tool  
<https://www.escha.net/en/products/standard/accessories-for-connectivity/8066215>

Cable Stripping Tool  
<https://www.escha.net/en/products/standard/accessories-for-connectivity/8066216>