

M12, female, angled, 4 poles, M12, male, angled, 4 poles, rail approved

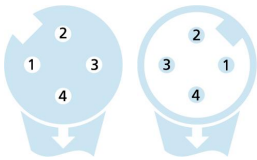
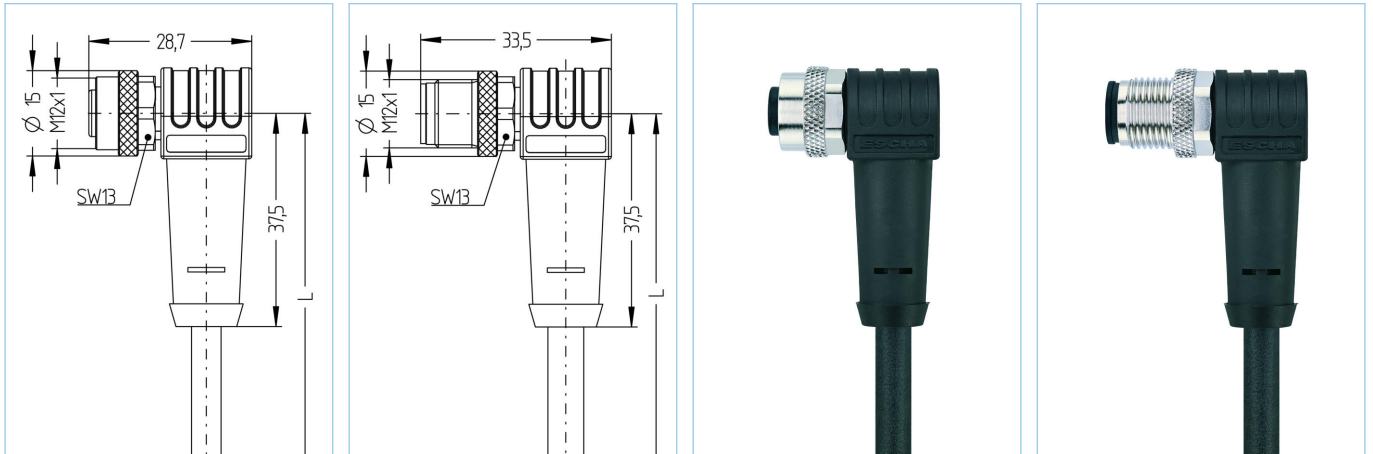

Product data	
Item description	RA-WWAK4.166-2-RA-WWAS4.166/S4500
Item-No.	8073335
Length	2m
Customs tariff-No.	85444290
Step-File	RA-WWAK4-L-RA-WWAS4.stp
EAN	4047106218324

Technical data	A-side	B-side
Connector	female, angled, M12	male, angled, M12
Number of pins	4	4
Pin assignment	1 WH 1, 2 WH 2, 3 WH 3, 4 WH 4	1 WH 1, 2 WH 2, 3 WH 3, 4 WH 4
Coding of	A	A
Rated voltage	250V	250V
Current load (at 40°C)	4A	4A
Insulation resistance	$\geq 10^8 \Omega$	$\geq 10^8 \Omega$
Resistance	$\leq 5m\Omega$	$\leq 5m\Omega$
Contact material	Metal, CuZn, gold-plated	Metal, CuZn, gold-plated
Contact-carrier material	Plastic, PA, BK	Plastic, PA, BK
Grip body material	Plastic, TPU, BK	Plastic, TPU, BK
Coupling nut material	Metal, CuZn, nickel-plated	Metal, CuZn, nickel-plated
Sealing (female) material	FPM/FKM	
Standards	IEC 61076-2-101	IEC 61076-2-101
Mechanical life-cycle	>100 mating cycles	>100 mating cycles
Degree of pollution	3	3

Advanced technical data rail approved	
Standards	DIN EN 50155, DIN EN 45545-2
Shock & vibration	Class 1, Category B (DIN EN 61373)
Degree of protection (mounted)	IP67 (-30°C...+90°C), IP65 (-40°C...+90°C)
Temperature range	Tx (-40°C...+90°C)
Fire prevention according to	DIN EN 45545-2 HL1-3

Cable web RADOX®, 4x0,5mm², S4500

Halogen-free, electron-beam cross-linked cable with improved behaviour in case of fire, easy to strip, soldering resistant and flexible. The cable is intended for fixed, mechanically protected installation inside railway vehicles or for installation in applications where limited alternating bending stresses occur during operation. The cable fulfills the requirements according to EN 50306-4 and EN 45545-2 (HL1 - HL3). It is characterized by a wide temperature range and a high oil- and fuel resistance. RADOX® is a registered trademark of HUBER+SUHNER AG, Switzerland.

Outer diameter of jacket	4.9 mm
Cable-jacket material	RADOX® EM 104
Jacket color	BK, similar RAL9005
Wire cross-section	4 x 0.5 mm ²
Wire insulation material	RADOX® EI 306
Wire colors	WH 1, WH 2, WH 3, WH 4
Wire structure	19 x 0,18 mm
Bending radius (fixed)	3xØ-cable
Bending radius (repeated)	4xØ-cable
Temperature range (fixed)	-40°C...+120°C
Fire prevention according to	DIN EN 45545-2 HL1-3, DIN 5510 fire prevention-levels 1-4, NF F16-101 category A1, A2, B
Halogen-free	Yes
Special features	increased thermal load, flame retardant, low emission of smoke, halogen free, oil- and fuel resistant, RoHs compliant

Classification

eCl@ss 6.0	27279218
eCl@ss 7.0	27279218
eCl@ss 8.0	27279218
eCl@ss 9.0	27060311
ETIM 5.0	EC001855
ETIM 6.0	EC001855

Accessories

Torque-wrench set https://www.escha.net/en/products/standard/accessories-for-connectivity/8055431
Marking rings Ø 9mm https://www.escha.net/en/products/standard/accessories-for-connectivity?p=1&o=3&n=15&f=809
Cable Stripping Tool https://www.escha.net/en/products/standard/accessories-for-connectivity/8066215
Screw plug, M12 https://www.escha.net/en/products/standard/accessories-for-connectivity?p=1&o=3&n=15&f=812
Screw cap, M12 https://www.escha.net/en/products/standard/accessories-for-connectivity?p=1&o=3&n=15&f=811
Mounting-clip, M12 https://www.escha.net/en/products/standard/accessories-for-connectivity/8047660
Mounting-set, M12 https://www.escha.net/en/products/standard/accessories-for-connectivity/8047664
Safety-clip, M12