

M12, male, straight, 8 poles, RJ45, male, straight, 8 poles, shielded, sensor-/actuator cable

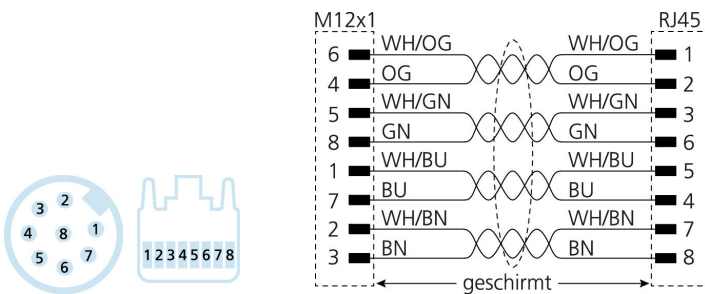
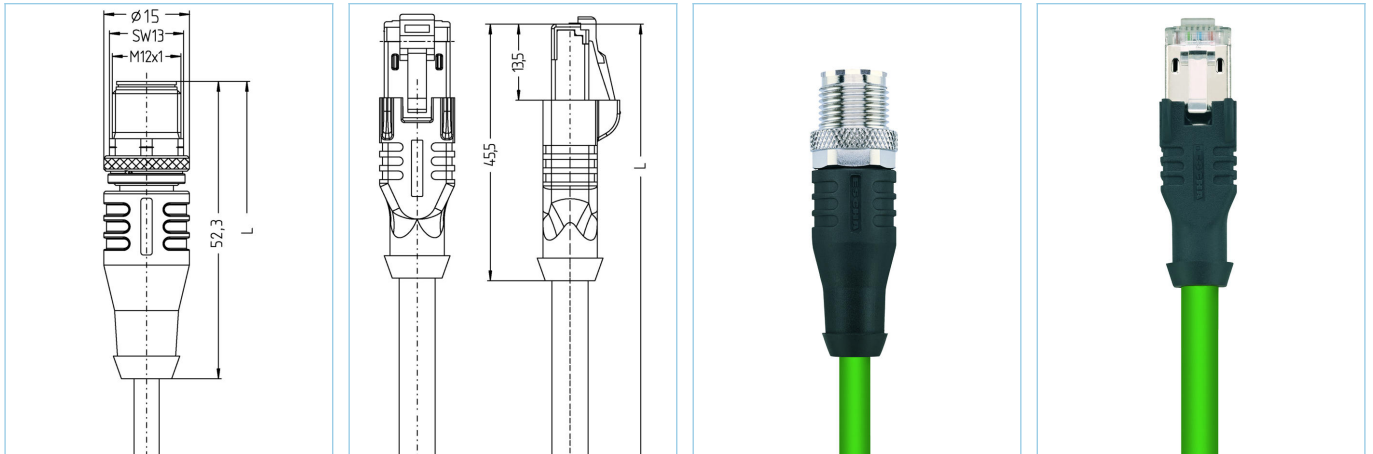

**Product data**

Item description	AL-WASS8.088-3-RJ45SS8.002/S3500
Item-No.	8072666
Length	3m
Customs tariff-No.	85444290
EAN	4047106227104

Technical data	A-side	B-side
Connector	male, straight, M12	male, straight, RJ45
Number of pins	8	8
Pin assignment	1 WH/BU, 2 WH/BN, 3 BN, 4 OG, 5 WH/GN, 6 WH/OG, 7 BU, 8 GN	1 WH/OG, 2 OG, 3 WH/GN, 4 BU, 5 WH/BU, 6 GN, 7 WH/BU, 8 BN
Allocation		T568B
Coding of	A	
Rated voltage	30V	50V
Current load (at 40°C)	2A	1A
Insulation resistance	$\geq 10^9 \Omega$	$\geq 10^9 \Omega$
Resistance	$\leq 5 m\Omega$	$\leq 5 m\Omega$
Ambient temperature product	-30°C...+90°C	-40°C...+70°C
Contact material	Metal, CuZn, gold-plated	Metal, CuZn, gold-plated
Contact-carrier material	Plastic, TPU, BK	Plastic
Grip body material	Plastic, TPU, BK	Plastic, TPE, BK
Coupling nut material	Metal, CuZn, nickel-plated	
Shielding	with shielding	with shielding
Material of shielding housing		Metal, CuZn, nickel-plated

Standards	IEC 61076-2-101	IEC 60603-7-5
Degree of protection (mounted)	IP65, IP67, IP68	IP20
Mechanical life-cycle	>100 mating cycles	>750 mating cycles
Degree of pollution	1	3

<b>Cable web</b>	<b>Cat7, PUR, UL, S3500</b>
------------------	-----------------------------

Shielded PUR-cable for industrial applications. The cable meets the UL-Style 20963 and the Cat7 (electrical properties according to EN50288-4-2) requirements. Materials and a constructive setup allow for increased mechanical stresses (abrasion, bending, vibrations etc.) of the cable.

Outer diameter of jacket	6.40 mm
Cable-jacket material	PUR
Jacket color	GN, similar RAL6018
Wire cross-section	4 x 2 x 0.14 mm <sup>2</sup>
Wire insulation material	PE
Wire colors	WH/OG ; WH/GN ; WH/BN ; WH/BU
Wire structure	7 x 0.16 mm
Bending radius (fixed)	5 x Ø-cable
Bending radius (repeated)	10 x Ø-cable
Temperature range (repeated)	-20°C...+60°C
Temperature range (fixed)	-40°C...+80°C
Shielding	Yes
Halogen-free	Yes
Transmission features	Cat7
Rated voltage cable	30 V UL rating
Special features	halogen free, high flexibility, hydrolysis proof, no fire propagation, no corrosive gases, LABS free, microbes resistant, oil resistant, recyclable, RoHS compliant, acid- and alkali resistant, seawater resistant, UV resistant

<b>Accessories</b>
--------------------

Torque-wrench set  
<https://www.escha.net/en/products/standard/accessories-for-connectivity/8055431>

Marking rings Ø 9mm  
<https://www.escha.net/en/products/standard/accessories-for-connectivity?p=1&o=3&n=15&f=809>

Screw cap, M12  
<https://www.escha.net/en/products/standard/accessories-for-connectivity?p=1&o=3&n=15&f=811>

Unlocking clip for RJ45  
<https://www.escha.net/en/products/standard/accessories-for-connectivity?p=1&o=3&n=15&f=807>