

Receptacle Double-ended cordset, M12, female, straight, 4 poles, D-coded, M12, male, angled, 4 poles, D-coded, shielded, rail approved

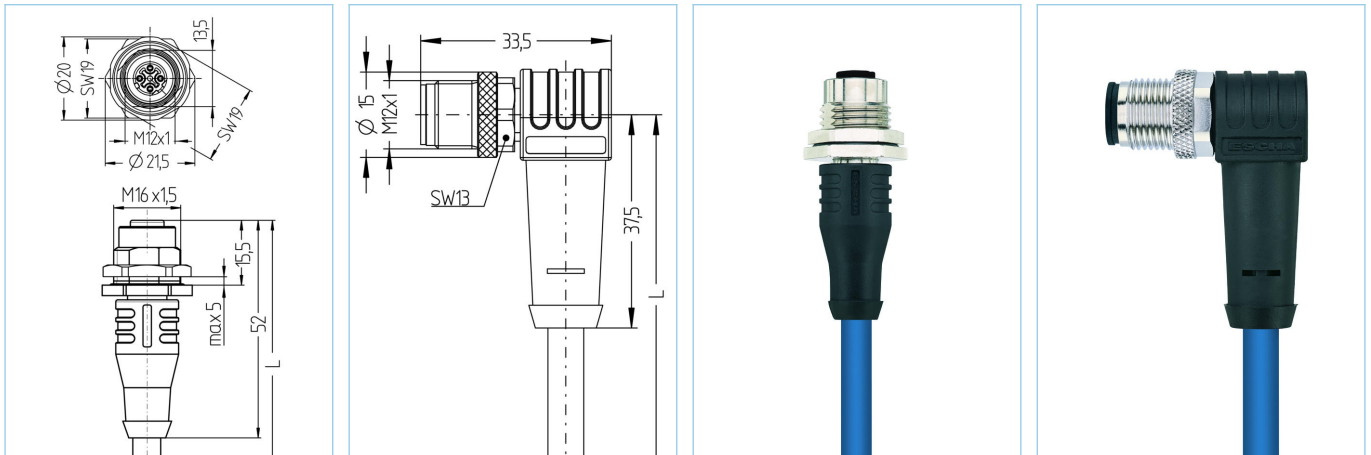

Product data

Item description	RA-FKFDSY4.029-10-RA-WWASSY4.029/S4004
Item-No.	8071426
Length	10m
Customs tariff-No.	85444290
Step-File	RA-FKFDSY4-L-RA-WWASSY4.stp
EAN	4047106217839

Technical data

	A-side	B-side
Connector	female, straight, M12	male, angled, M12
Number of pins	4	4
Pin assignment	1 YE, 2 WH, 3 OG, 4 BU	1 YE, 2 WH, 3 OG, 4 BU
Coding of	D	D
Rated voltage	60V	60V
Current load (at 40°C)	4A	4A
Insulation resistance	$\geq 10^8 \Omega$	$\geq 10^8 \Omega$
Resistance	$\leq 5m\Omega$	$\leq 5m\Omega$
Transmission features	Cat5e	Cat5e
Contact material	Metal, CuZn, gold-plated	Metal, CuZn, gold-plated
Contact-carrier material	Plastic, PA, BK	Plastic, PA, BK
Grip body material	Plastic, TPU, BK	Plastic, TPU, BK
Coupling nut material	Metal, CuZn, nickel-plated	Metal, CuZn, nickel-plated
Receptacle housing material	Metal, CuZn, nickel-plated	
Sealing (female) material	FPM/FKM	
Material of external sealing	NBR	
Shielding	with shielding	with shielding
Mounting direction	Back wall-mounting (incl. Fixing screw)	
Fastening thread	M16x1,5	

Wall thickness area (Δh)	1,0...5,0 mm	
Standards	IEC 61076-2-101	IEC 61076-2-101
Mechanical life-cycle	>100 mating cycles	>100 mating cycles
Degree of pollution	3	3

Advanced technical data rail approved

Standards	DIN EN 50155, DIN EN 45545-2
Shock & vibration	Class 1, Category B (DIN EN 61373)
Degree of protection (mounted)	IP67 (-30°C...+90°C), IP65 (-40°C...+90°C)
Temperature range	Tx (-40°C...+90°C)
Fire prevention according to	DIN EN 45545-2 HL1-3

Cable web

Cat5, RADOX®, ECO, 1x4xAWG22, S4004

Halogen-free, electron-beam cross-linked Cat5-cable with improved fire performance. Excellent features regarding NEXT, attenuation and screening characteristics (pair- and overall screen). This cable can be used for fixed and protected installation inside of rail vehicles and busses and fulfills the requirements according to EN 45545-2 (HL1 - HL3). It is optimally suited for all Ethernet applications of classes D to F (ECN and ETB) according to IEE 802.3. For installation the guidelines of EN 50355 and EN 50343 must be considered. With a modified composition of materials and consistent technical features, this cable offers a cost-effective alternative to S4003. RADOX® is a registered trademark of HUBER+SUHNER AG, Switzerland.

Outer diameter of jacket	7.25 mm
Cable-jacket material	RADOX® EM 104
Jacket color	BU
Wire cross-section	1 x 4 x AWG22, star quad
Wire insulation material	RADOX® COM
Wire colors	WH, BU, OG, YE
Bending radius (fixed)	6xØ cable
Bending radius (repeated)	10xØ cable
Temperature range (fixed)	-50°C...+90°C
Fire prevention according to	DIN EN 45545-2 HL1-3, DIN 5510 fire prevention-levels 1-4, NF F16-101 category A1, A2, B, UNI CEI 11170, danger level LR1-LR4, NFPA 130, UN ECE R 118
Shielding	Yes
Halogen-free	Yes
Transmission features	Cat5e
Special features	increased thermal load, flame retardant, low emission of smoke, halogen free, oil- and fuel resistant, RoHs compliant

Classification

eCl@ss 6.0	27060307
eCl@ss 7.0	27060307
eCl@ss 8.0	27060307
eCl@ss 9.0	27060307
ETIM 5.0	EC000830
ETIM 6.0	EC000830

Accessories

Torque-wrench set

<https://www.escha.net/en/products/standard/accessories-for-connectivity/8055431>

Marking rings Ø 9mm

<https://www.escha.net/en/products/standard/accessories-for-connectivity?p=1&o=3&n=15&f=809>

Cable Stripping Tool

<https://www.escha.net/en/products/standard/accessories-for-connectivity/8066215>

Screw plug, M12

<https://www.escha.net/en/products/standard/accessories-for-connectivity/8081767>

Screw cap, M12

<https://www.escha.net/en/products/standard/accessories-for-connectivity/8081753>

Mounting-clip, M12

<https://www.escha.net/en/products/standard/accessories-for-connectivity/8047660>

Mounting-set, M12

<https://www.escha.net/en/products/standard/accessories-for-connectivity/8047664>

Safety-clip, M12

Spare nuts for receptacle

<https://www.escha.net/en/products/standard/accessories-for-connectivity/8029359>