

Receptacle Double-ended cordset, M12, female, straight, 8 poles, X-coded, RJ45, male, straight, 8 poles, shielded, Industrial Ethernet

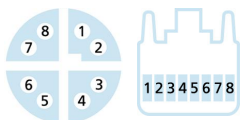

PROFI  
NET

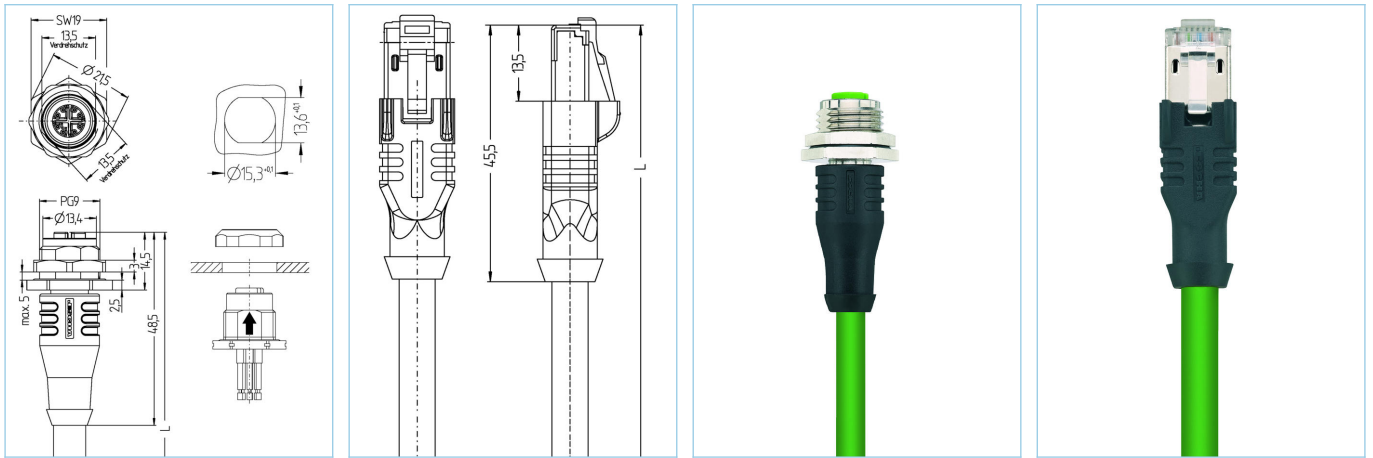

Product data

Item description	IE-FKFDSX8.066-1,5-IE-RJ45SS8.002/S3500
Item-No.	8064569
Length	1.5m
Customs tariff-No.	85444290
Step-File	IE-FKFDSX8-m-IE-RJ45SS8.stp
EAN	4047106214043

Technical data	A-side	B-side
Connector	female, straight, M12	male, straight, RJ45
Number of pins	8	8
Pin assignment	1 WHOG, 2 OG; 3 WHGN, 4 GN; 5 WHBN, 6 BN; 7 WHBU, 8 BU	1 WHOG, 2 OG; 3 WHGN, 4 BU; 5 WHBU, 6 GN; 7 WHBN, 8 BN
Coding of	X	
Rated voltage	50V <sub>AC</sub>   60V <sub>DC</sub>	60V
Current load (at 40°C)	0.5A	1A
Insulation resistance	≥10 <sup>9</sup> Ω	
Transmission features	Cat6A	Cat6A
Ambient temperature product	-30°C...+90°C	-40°C...+70°C
Contact material	Metal, CuSn, gold-plated	Metal, CuZn, gold-plated
Contact-carrier material	Plastic, PA, GN	Plastic
Grip body material	Plastic, TPU, BK	Plastic, TPU, BK
Receptacle housing material	Metal, CuZn, nickel-plated	
Sealing (female) material	FPM/FKM	
Material of external sealing	NBR	
Shielding	with shielding	with shielding
Material of shielding housing		Metal, CuZn, nickel-plated
Standards	IEC 61076-2-101/-109	IEC 60603-7-51
Degree of protection (mounted)	IP65, IP67, IP68	IP20
Mechanical life-cycle	>100 mating cycles	>750 mating cycles
Degree of pollution	3	1

<b>Cable web</b>	<b>Cat7, PUR, UL, S3500</b>
------------------	-----------------------------

Shielded PUR-cable for industrial applications. The cable meets the UL-Style 20963 and the Cat7 (electrical properties according to EN50288-4-2) requirements. Materials and a constructive setup allow for increased mechanical stresses (abrasion, bending, vibrations etc.) of the cable.

Outer diameter of jacket	6.40 mm
Cable-jacket material	PUR
Jacket color	GN, similar RAL6018
Wire cross-section	4 x 2 x 0.14 mm <sup>2</sup>
Wire insulation material	PE
Wire colors	WH/OG ; WH/GN ; WH/BN ; WH/BU
Wire structure	7 x 0.16 mm
Bending radius (fixed)	5 x Ø-cable
Bending radius (repeated)	10 x Ø-cable
Temperature range (repeated)	-20°C...+60°C
Temperature range (fixed)	-40°C...+80°C
Shielding	Yes
Halogen-free	Yes
Transmission features	Cat7
Rated voltage cable	30 V UL rating
Special features	halogen free, high flexibility, hydrolysis proof, no fire propagation, no corrosive gases, LABS free, microbes resistant, oil resistant, recyclable, RoHS compliant, acid- and alkali resistant, seawater resistant, UV resistant

<b>Classification</b>	
-----------------------	--

eCl@ss 6.0	27060307
eCl@ss 7.0	27060307
eCl@ss 8.0	27060307
eCl@ss 9.0	27060307
ETIM 5.0	EC000830
ETIM 6.0	EC000830