

7/8", female, straight, 5 poles, 7/8", male, straight, 5 poles

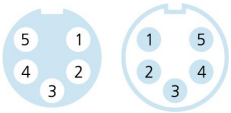
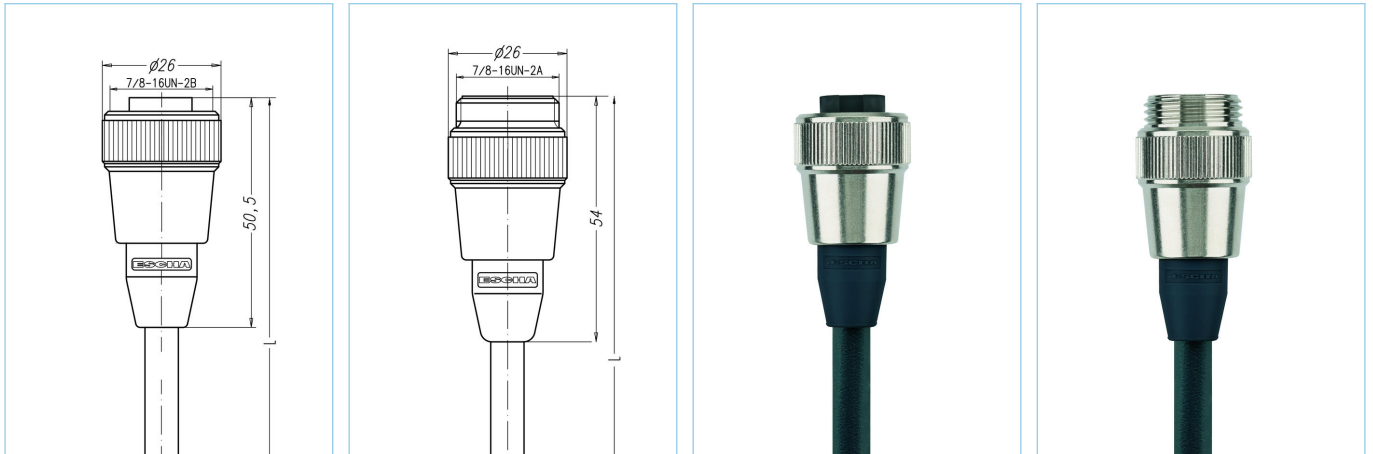

Product data

| | |
|--------------------|----------------------------|
| Item description | WAKM50-1-WASM50/S370/S3917 |
| Item-No. | 8057400 |
| Length | 1m |
| Customs tariff-No. | 85444290 |
| EAN | 4047106182670 |

Technical data

| | A-side | B-side |
|--------------------------------|--------------------------------|--------------------------------|
| Connector | female, straight, 7/8" | male, straight, 7/8" |
| Number of pins | 5 | 5 |
| Pin assignment | 1 BK, 2 BU, 3 GNYE, 4 BN, 5 WH | 1 BK, 2 BU, 3 GNYE, 4 BN, 5 WH |
| Coding of | A | A |
| Rated voltage | 250V | 250V |
| Current load (at 40°C) | 10A | 10A |
| Insulation resistance | $\geq 10^9 \Omega$ | $\geq 10^9 \Omega$ |
| Resistance | $\leq 5 m\Omega$ | $\leq 5 m\Omega$ |
| Ambient temperature product | -30°C...+90°C | -30°C...+90°C |
| Contact material | Metal, CuSn, gold-plated | Metal, CuSn, gold-plated |
| Contact-carrier material | Plastic, TPU, BK | Plastic, TPU, BK |
| Grip body material | Plastic, TPU, transparent | Plastic, TPU, BK |
| Coupling nut material | Metal, CuZn, nickel-plated | Metal, CuZn, nickel-plated |
| Degree of protection (mounted) | IP65, IP67, IP68 | IP65, IP67, IP68 |
| Mechanical life-cycle | >100 mating cycles | >100 mating cycles |
| Degree of pollution | 3 | 3 |

| | |
|------------------|----------------------|
| Cable web | PUR, UL, S370 |
|------------------|----------------------|

Flexible, silicone- and halogen-free control line with high mechanical strength. The cable is chemicals, hydrolysis-, and microbes- resistant. The drag-chain application is possible at a bending radius of minimum 10 x d. Due to its weld-field immunity, the cable is very well suited for the flexible application in robotics, machine-tool, and metal-cutting production. The cables meet the UL and CSA (UL10493/20549; cULus) requirements.

| | |
|--------------------------------|--|
| Outer diameter of jacket | 8.5 mm |
| Cable-jacket material | PUR |
| Jacket color | BK, similar RAL9005 |
| Wire cross-section | 5 x 1.5 mm ² |
| Wire insulation material | PP |
| Wire colors | BN, WH, BU, BK, GNYE |
| Wire structure | 84 x 0,15 mm |
| Bending radius (fixed) | 5 x Ø-cable |
| Bending radius (repeated) | 10 x Ø-cable |
| Temperature range (repeated) | -30°C...+90°C |
| Temperature range (fixed) | -40°C...+90°C |
| Temperature range (drag chain) | -25°C...+60°C |
| Drag chain-application | ≥1 Mio. cycles |
| Halogen-free | Yes |
| Torsion | +/-180°/m, ≥ 0.1 Mio. cycles |
| Rated voltage cable | ≤300 V |
| Special features | flame retardant, halogen free, hydrolysis proof, LABS free, oil resistant, ozone resistant, recyclable, RoHs compliant, acid- and alkali resistant, drag chain-adapted, welding sparks resistant, seawater resistant, silicone free, torsion resistant, UV resistant |

| | |
|-----------------------|--|
| Classification | |
|-----------------------|--|

| | |
|------------|----------|
| eCl@ss 6.0 | 27279218 |
| eCl@ss 7.0 | 27279218 |
| eCl@ss 8.0 | 27279218 |
| eCl@ss 9.0 | 27060311 |
| ETIM 5.0 | EC001855 |
| ETIM 6.0 | EC001855 |