

I/O-junctions passive, 4 ports, fixed cable connection, M12, female, 3+PE

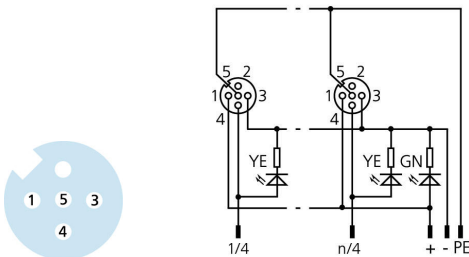
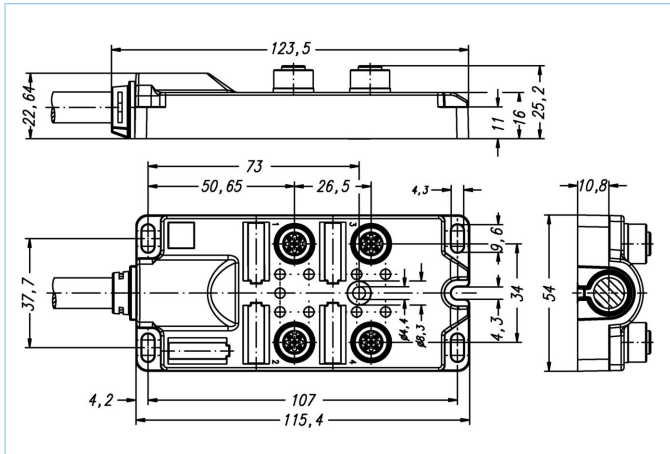

Product data

Item description	4I/OM12-5.4P2C-5/S370
Item-No.	8051988
Length	5m
Customs tariff-No.	85444290
Step-File	4I_OM12-5_4P2C-m.stp
EAN	4047106094164
Remark	Labels (white) not included

Technical data

I/O-junction	4-way, with cable
I/O-slot	female, M12
Number of pins	3+PE
Rated voltage	30V
Current load per pin (at 40°C)	2A
Total current load	12A
Insulation resistance	≥10 ⁹ Ω
Resistance	≤ 5mΩ
Ambient temperature product	-30°C...+90°C
Number of LEDs	5
Number of I/O-slots	4
Circuit logic	pnp
Signal status-indicator	LED YE
Operating voltage-indicator	LED GN
Contact material	Metal, CuZn, gold-plated
Contact-carrier material	Plastic, PA, BK
Sealing (female) material	FPM/FKM
Housing material	Plastic, PA, BK

Thread insert material	Metal, CuZn
Connecting type	Fixed cable connection
Standards	IEC 61076-2-101
Degree of protection (mounted)	IP65, IP67
Mechanical life-cycle	>100 mating cycles
Degree of pollution	3

Cable web	PUR, UL, S370
------------------	----------------------

Flexible, silicone- and halogen-free control line with high mechanical strength. The cable is chemicals, hydrolysis-, and microbes- resistant. The drag-chain application is possible at a bending radius of minimum 10 x d. Due to its weld-field immunity, the cable is very well suited for the flexible application in robotics, machine-tool, and metal-cutting production. The cables meet the UL and CSA (UL10493/20549; cULus) requirements.

Outer diameter of jacket	7.5 +/- 0.3 mm
Cable-jacket material	PUR
Jacket color	BK, similar RAL9005
Wire cross-section	4 x 0.34 mm ² + 3 x 1 mm ²
Wire insulation material	PP
Wire colors	WH, GN, YE, GY, BU, BN, GNYE
Bending radius (fixed)	5 x Ø-cable
Bending radius (repeated)	10 x Ø-cable
Temperature range (repeated)	-30°C...+90°C
Temperature range (fixed)	-40°C...+90°C
Temperature range (drag chain)	-25°C...+60°C
Drag chain-application	2 Mio. cycles
Halogen-free	Yes
Rated voltage cable	≤300 V
Special features	flame retardant, halogen free, hydrolysis proof, LABS free, oil resistant, ozone resistant, recyclable, RoHs compliant, acid- and alkali resistant, drag chain-adapted, welding sparks resistant, seawater resistant, silicone free, torsion resistant, UV resistant

Allocation chart

I/O	1	2	3	4	all (+)	all (-)	all (FE)
Pin	4	4	4	4	1	3	5
Cable	WH	GN	YE	GY	BN	BU	GNYE

Classification

eCl@ss 6.0	27279219
eCl@ss 7.0	27279219
eCl@ss 8.0	27279219
eCl@ss 9.0	27440108
ETIM 5.0	EC002585
ETIM 6.0	EC002585

Accessories

Screw plug, M12

<https://www.escha.net/en/products/standard/accessories-for-connectivity/8081767>

Labels, I/O-junction passive, I/O-junction active

<https://www.escha.net/en/products/standard/accessories-for-connectivity/8015002>

Accessories set, I/O-junction passive, M12

<https://www.escha.net/en/products/standard/accessories-for-connectivity/8087215>