

M12, female, angled, 12 poles, M12, male, angled, 12 poles, sensor-/actuator cable

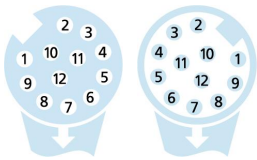
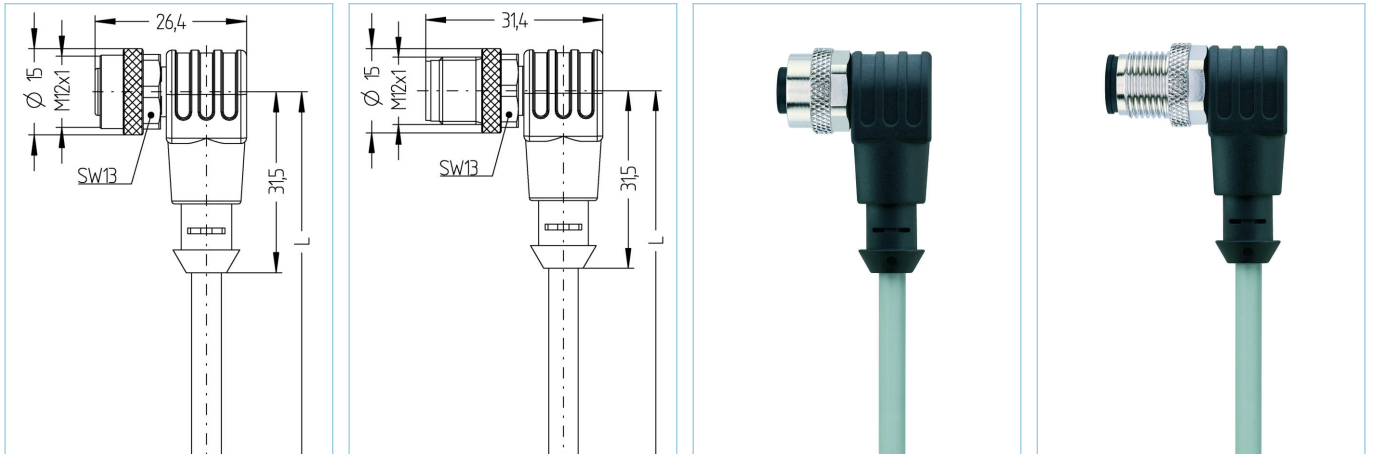

Product data		
Item description	AL-WWAK12-2-AL-WWAS12/P00	
Item-No.	8051523	
Length	2m	
Customs tariff-No.	85444290	
Step-File	AL-WWAK12-m-AL-WWAS12.stp	
EAN	4047106022549	
Technical data	A-side	B-side
Connector	female, angled, M12	male, angled, M12
Number of pins	12	12
Pin assignment	1 BN, 2 BU, 3 WH, 4 GN, 5 PK, 6 YE, 7 BK, 8 GY, 9 RD, 10 VT, 11 GYPK, 12 RDBU	1 BN, 2 BU, 3 WH, 4 GN, 5 PK, 6 YE, 7 BK, 8 GY, 9 RD, 10 VT, 11 GYPK, 12 RDBU
Coding of	A	A
Rated voltage	30V	30V
Current load (at 40°C)	1.5A	1.5A
Insulation resistance	$\geq 10^9 \Omega$	$\geq 10^9 \Omega$
Resistance	$\leq 5m\Omega$	$\leq 5m\Omega$
Ambient temperature product	-30°C...+90°C	-30°C...+90°C
Contact material	Metal, CuZn, gold-plated	Metal, CuZn, gold-plated
Contact-carrier material	Plastic, TPU, BK	Plastic, TPU, BK
Grip body material	Plastic, TPU, BK	Plastic, TPU, BK
Coupling nut material	Metal, CuZn, nickel-plated	Metal, CuZn, nickel-plated
Sealing (female) material	FPM/FKM	
Standards	IEC 61076-2-101	IEC 61076-2-101
Degree of protection (mounted)	IP65, IP67, IP68	IP65, IP67, IP68
Mechanical life-cycle	>100 mating cycles	>100 mating cycles
Degree of pollution	3	3

Cable web	PVC, P00, GY
------------------	---------------------

PVC-cable for measurement and control-, and sensor technology. Suitable for applications in dry areas on packaging machines, assembly- and conveyor technology. High flexibility with unstressed movement (conditional drag-chain application possible). Predestined for applications in food- and beverage industry.

Outer diameter of jacket	6.10 mm
Cable-jacket material	PVC
Jacket color	GY, similar RAL7040
Wire cross-section	12 x 0.14 mm ²
Wire insulation material	PVC
Wire colors	BN, BU, WH, GN, PK, YE, BK, GY, RD, VT, GYPK, RDBU
Wire structure	18 x 0.10 mm
Bending radius (fixed)	5 x Ø-cable
Bending radius (repeated)	10 x Ø-cable
Temperature range (repeated)	0°C...+80°C
Temperature range (fixed)	-25°C...+80°C
Rated voltage cable	≤300 V
Special features	good resistance against oils and chemicals, LABS free, ozone resistant, recyclable, RoHs compliant, acid- and alkali resistant, seawater resistant, UV resistant

Classification

eCl@ss 6.0	27279218
eCl@ss 7.0	27279218
eCl@ss 8.0	27279218
eCl@ss 9.0	27060311
ETIM 5.0	EC001855
ETIM 6.0	EC001855

Accessories

Mounting-clip, M12 https://www.escha.net/en/products/standard/accessories-for-connectivity/8047660
Torque-wrench set https://www.escha.net/en/products/standard/accessories-for-connectivity/8055431
Marking rings Ø 9mm https://www.escha.net/en/products/standard/accessories-for-connectivity?p=1&o=3&n=15&f=809
Screw plug, M12 https://www.escha.net/en/products/standard/accessories-for-connectivity?p=1&o=3&n=15&f=812
Screw cap, M12 https://www.escha.net/en/products/standard/accessories-for-connectivity?p=1&o=3&n=15&f=811

Link to product

https://www.escha.net/en/products/standard/sensoractuator-connectors/8051523
